

Haier



MRV sistemi
Kommercijalna serija
Kućna serija



KATALOG

KLIMA UREĐAJA

2023/2024.

Haier KLIMA UREĐAJI

Profesionalna klimatizacija
s rješenjima za zdrav zrak u domu.

Haier VIZIJA

Biti prepoznat kao lider u globalnoj HVAC industriji po tehnološkim inovacijama, kvalitetnim proizvodima i uspješnom poslovnom modelu.

Haier MISIJA

Razvijati inovativnu tehnologiju u segmentu pametnog upravljanja i unaprjeđivati funkcije za poboljšanje kvalitete zraka.



SADRŽAJ

Haier GRUPA	/02
Haier globalna pozicija	/04
Haier Centar za istraživanje	/05
Haier pregled značajnih događaja	/06
Haier što je novo u 2023. godini	/07
Haier RJEŠENJA ZA KLIMATIZACIJU DOMA	/08
Ultimativno zdravlje	/10
Ultimativne pametne funkcije	/20
Ultimativni komfor	/24
Ultimativna fleksibilnost	/31
LINIJA MODELA KLIMA	/34
Pregled funkcija	/34
Prednosti	/40
Pregled modela	/44
KUĆNA SERIJA KLIMA UREĐAJA	/46
Jade	/46
Expert Nordic	/48
Expert	/50
Flexis Plus	/52
Pearl	/54
Tundra Plus	/56
Tide Plus	/58
Mobilni klima uređaj	/60
R32 SUPER MATCH MULTI SUSTAVI	/62
Pregled modela	/64
Multi inverter	/68
KOMERCIJALNA SERIJA KLIMA UREĐAJA	/70
Kompaktni kazetni model	/72
360° kazetni model	/74
Slim kanalni model	/76
Kanalni model srednji ESP	/78
Kanalni model visoki ESP	/80
Podnostropni model	/82
Podni inverter model	/84
Haier MRV SISTEMI	/86
MRV sustavi	/89
TEHNIČKI PODACI	/94
Upravljanje	/94
Dimenzije unutarnjih jedinica	/96
Dimenzije vanjskih jedinica	/98

Haier GLOBALNA POZICIJA



SVJETSKI BROJ 1

Haier je 13 godina za redom proglašen najvećim svjetskim brandom bijele tehnike u svijetu po količini prodaje. Istraživanje je napravljeno od strane neovisne agencije za istraživanje svjetskog tržišta Euromonitor International.



SVJETSKI BROJ 1 U KATEGORIJI "PAMETNIH" KLIMA UREĐAJA

Haier je ostvario 33,3% tržišnog udjela u kategoriji „pametnih“ klima uređaja.



"ESG" INTERNATIONAL AWARDS

2021. Haier je osvojio svjetsku nagradu BDO ESG (Održivi razvoj, društvena odgovornost i izvješćivanje o upravljanju).



FORTUNE: HAIER MEĐU NAJCJENJENIJIM KOMPANIJAMA

Brand Haier proglašen je jedan od najcjjenjenijih brandova u svijetu za 2022. godinu na temelju razvojne strategije u čijem središtu je krajnji korisnik.



BRANDZ TOP 100 NAJVRJEDNIJIH BRANDOVA

BrandZ™ predstavlja Top 100 najcjjenjenijih svjetskih brandova 2020. među kojima je Haier osvojio 1. mjestu u kategoriji IoT (Internet of Things) brend ekosustava.



FORTUNE GLOBAL 500

2021. Fortune GLOBAL 500 uvrstio je kompaniju Haier Smart Home Co među TOP 500 kompanija zahvaljujući jasnoj viziji u segmentu pametnog ekosustava. Pametni ekosustavi pomažu korisnicima da automatiziraju svakodnevne zadatke.

Haier CENTAR ZA ISTRAŽIVANJE I RAZVOJ



Haier & Mitsubishi
Joint Laboratory

Haier & Highly
Joint Laboratory

Laboratorij za istraživanje i razvoj



Comfort Test



Rainfall Test



Performance Test



Safety Test



Noise Test



EMC Test



Snow Test

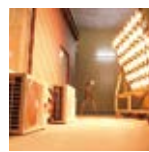

Sunshine Test



Reliability Test



Humidity Test



Double 85 Test



Drop Test

Popis certifikata



Haier PREGLED ZNAČAJNIH DOGAĐAJA

MB FRIGO

MB Frigo Grupa postaje
generalni distributer Haier
klimatizacijskih sustava
na području Adria regije.

2001



Započinje izvoz
klima uređaja u SAD.

1999



Lansirana
komercijalna
serija klima uređaja.

1996



Stečen certifikat
ISO9001.

1994



Lansiran prvi
inverter klima uređaj.

1993



Osnovan u
Qingdau, Kina.

1984



6. godinu zaredom
Svjetski br. 1
u kategoriji "pametnih"
klima uređaja.

2022



Osmišljena
UVC tehnologija.

2021



Akvizicija
kompanije Candy.

2018



Akvizicija
kompanije GE.

2016



Osmišljena IoT
tehnologija.

2015



Haier ŠTO JE NOVO U 2023. GODINI?



reddot winner 2022



NOVO Expert Nordic

- UVC Pro
- Eco sensor
- 30°C grijanje
- Easy to clean



Haier RJEŠENJA ZA KLIMATIZACIJU DOMA

Odaberite komfor i čist zrak u domu

KUĆNA SERIJA
KLIMA UREĐAJA





ULTIMATIVNE FUNKCIJE ZA ZDRAVLJE



ULTIMATIVNE PAMETNE FUNKCIJE



ULTIMATIVNE FUNKCIJE ZA KOMFOR



ULTIMATIVNE FUNKCIJE ZA MONTAŽU



Ultimativno zdravlje

ODRŽAVANJE KLIMA UREĐAJA ČISTIM



FROST CLEAN

Automatsko samočišćenje hladnom ekspanzijom - zaleđivanjem površine isparivača učinkovito se uklanjaju nečistoće i bakterije.



56°C STERILIZACIJA

Ubija bakterije i viruse zagrijavanjem isparivača na visokih 56°C tijekom 30 minuta.



SELF HYGIENE

Komponente kroz koje prolazi zrak zaštićene su premazom koji sadrži srebrne nanočestice. Eliminacija plijesni i bakterija iz zraka do 99,9%.



EASY TO CLEAN

Inovacija za čist zrak koja omogućuje jednostavno vađenje ventilatora i filtera za dubinsko čišćenje klima uređaja.



Ultimativno zdravlje

ISPORUKA ZDRAVOG ZRAKA



SUPER IFD STERILIZACIJA

Uklanja viruse i bakterije u prostoriji s učinkovitošću do 99,9%

SGS



PURI -CLEAN

Koristi napredni IFD filter za pročišćavanje koji uklanja sve vrste zagađivača i alergena iz zraka s učinkovitošću do 99,9%.

TÜV Rheinland

Intertek

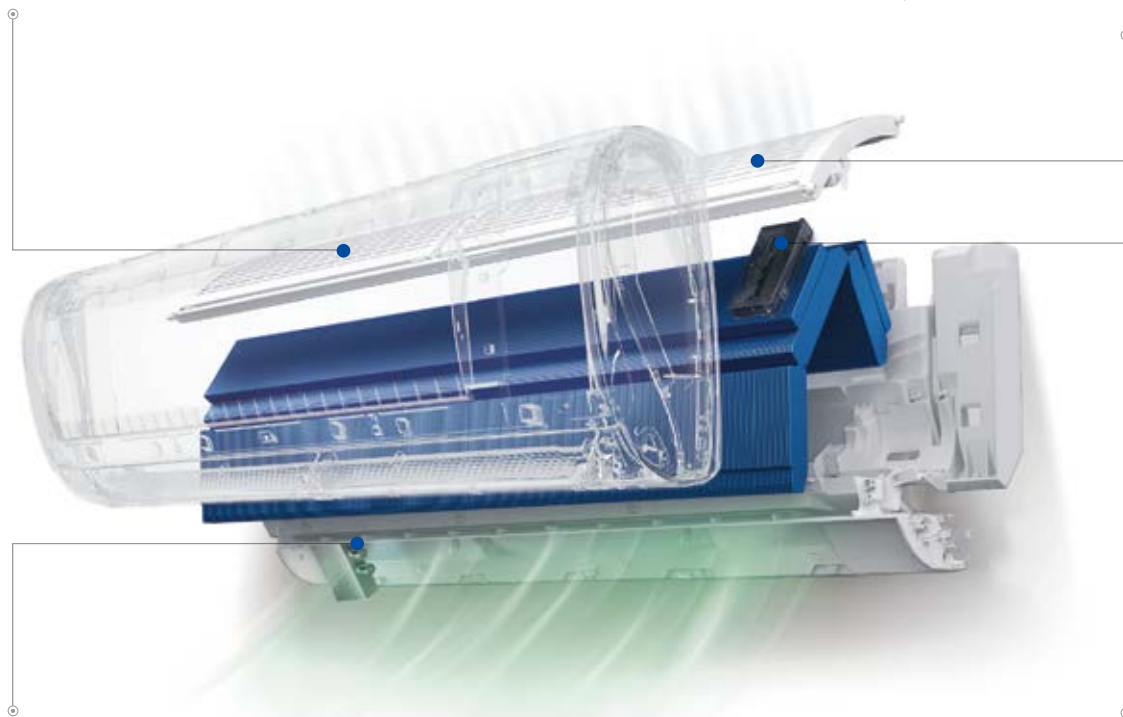

UVC PRO MODUL + IONIZATOR

UVC Pro istovremeno sterilizira unutarnju jedinicu i zrak u prostoriji. Uz pomoć UVC zraka i plazme, osigurana je vrhunska kvaliteta zraka i čistoća uređaja.

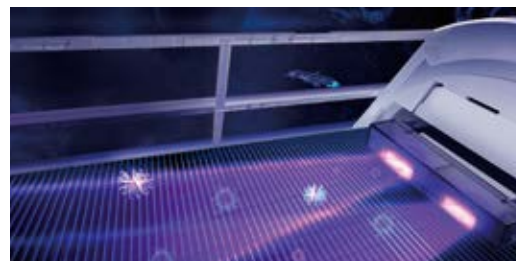

UVC STERILIZACIJA

Ugrađeno UV LED svjetlo sterilizira zrak koji cirkulira klima uređajem. Učinkovito eliminira viruse i bakterije pri čemu isporučuje zdrav zrak u prostoriju.

Texcell

ULTIMATIVNO ZDRAVLJE

Uvijek čist i svjež zrak



Znate li da kroz klima uređaj prolazi sav zrak iz zatvorene prostorije i to više puta dnevno? U zatvorenim prostorima provodimo najviše vremena te kvaliteta zraka koji udišemo izravno utječe na naše zdravlje. Zagađeni zrak izvana ulazi u uredske prostorije ili naš dom kroz prozore i vrata, ali i kroz ventilaciju. S zrakom u prostor dolaze i štetne čestice od ispušnih plinova, čađe, prašine, peludi, itd.

U većim gradovima, pogotovo u područjima s frekventnijim prometom, zrak je još zagađeniji.

Haier već godinama razvija dodatne funkcije za pročišćavanje zraka u klima uređajima kako bi korisnicima omogućio svjež i pročišćen zrak u njihovim domovima.

Početak 2020. brand Haier dobio je svjetsku potvrdu od neovisne agencije za istraživanje svjetskog tržišta Euromonitor International za najučinkovitije antialergijsko djelovanje klima uređaja "Allergy-Free Tick-Mark Certificate" i postao najprodavaniji brand klima uređaja u kategoriji sterilizacije zraka.

Čistoća klima uređaja



Frost Clean



56°C Sterilizacija



Self-higiene



Easy to clean

Pročišćavanje zraka



UVC Sterilizacija



UVC PRO
Sterilizacija



Puri-Clean



IFD Sterilizacija

FROST CLEAN

Automatsko samočišćenje hladnom ekspanzijom – zaleđivanjem površine isparivača učinkovito se uklanjaju nečistoće i bakterije.



TEHNOLOGIJA

Koristi vlagu iz zraka kako bi smrznula površinu isparivača, te na taj način vezala čestice nečistoće, da bi ih zatim brzim zagrijavanjem otopila i kroz odvod uklonila. Uz to, dodatnim zagrijavanjem isparivača, dodatno se uništavaju bakterije kako bi izlazni zrak bio 99% čist.

Hladna ekspanzija



Zaleđivanjem površine isparivača učinkovito se uklanjaju nečistoće i bakterije.

Express tehnologija pranja



Hidrofilni aluminij s manjim kutom pomaže povećati učinkovitost odvodnje vode za 20%.

Antibakterijska tehnologija



Ionski srebrni premaz na isparivaču uz pomoć kojeg se dobiva 99,9% dezinficirani zrak. Ionsko srebro djeluje kao antiseptik zbog njegovih iona koji mogu prodirjeti kroz membranu bakterija.

PREDNOSTI

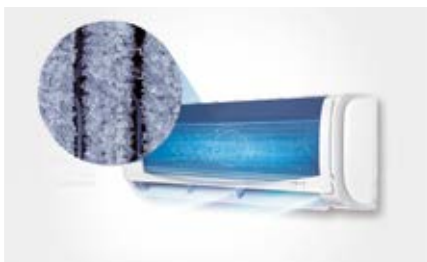

Isporuka čistog zraka

Inovativna tehnologija ubija bakterije i dezinficira isparivač.



Ušteda troškova čišćenja

Čišćenje klima uređaja jednostavnim klikom na upravljač bez dodatnih troškova.

TUV CERTIFIKAT



56°C STERILIZACIJA

Ubija bakterije i viruse zagrijavanjem isparivača na visokih 56°C tijekom 30 minuta.

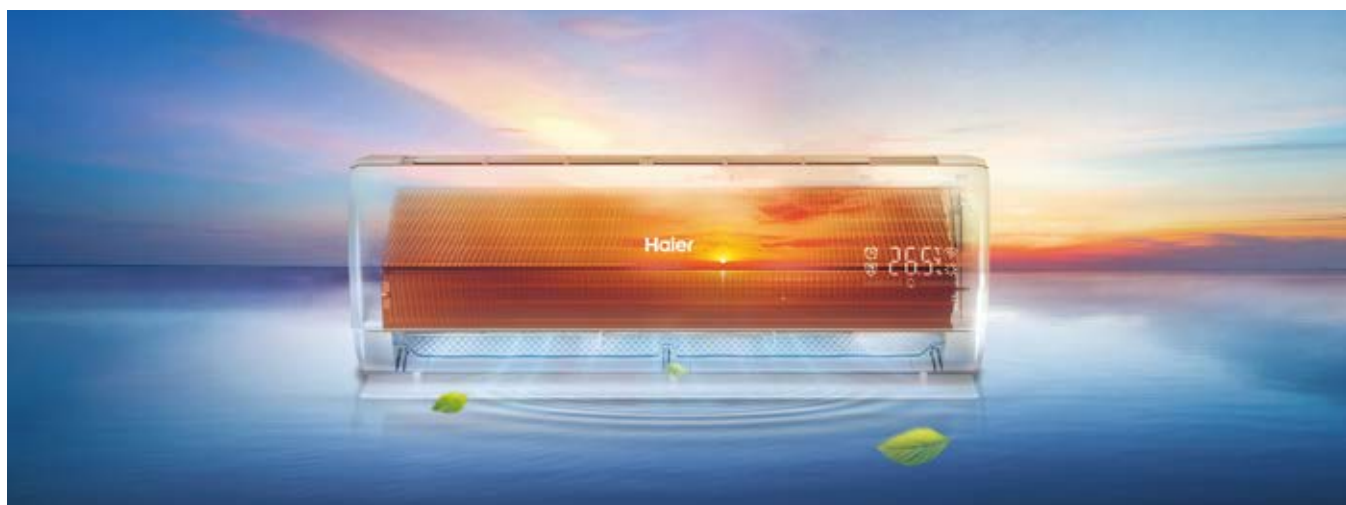

TEHNOLOGIJA



30+

minuta
Sterilizacija na visokoj temperaturi

Pametna kontrola frekvencije kompresora

Inteligentno podešava frekvenciju kompresora za kontrolu temperature zavojnice, a zatim održava isparivač na visokih 56°C.

Učinkovita sterilizacija na visokoj temperaturi

Prema istraživanju, bakterije i virusi ne mogu preživjeti na temperaturi od 56°C (30 minuta). Nakon završetka postupka zagrijavanja, isparivač se trenutno hladi kako bi se postigla bolja izvedba sterilizacije.



SGS CERTIFIKAT



PREDNOSTI

Ispuh zdravog zraka

56°C sterilizacija visokom temperaturom suši komponente iznutra i ubija bakterije i viruse te tako osigurava ispuh zdravog zraka.

Jednostavno korištenje

Funkcija 56°C sterilizacija je dostupna putem mobilne aplikacije hOn, a može se uključiti jednim klikom.

PURI-CLEAN

Haier koristi napredni IFD filter za pročišćavanje koji uklanja sve vrste onečišćenja i alergena u zraku s učinkovitošću do 99,9%.



TEHNOLOGIJA

Super IFD filter



Super IFD filter sastoji se od 6818 ventilacijskih rupa na površini od 8180 cm². IFD filter pročišćava zrak uz pomoć statičkog elektriciteta koji uništava i najsitnije nečistoće u zraku.

Pametni senzor za kvalitetu zraka



Inovativni senzor u unutarnjoj jedinici klima uređaja upozorava korisnika na kvalitetu zraka. Previše čestica prašine u prostoriji aktivira senzor i na displayu unutarnje jedinice pokazuje upozorenje (Crvena boja - zrak nije kvalitetan / Zelena boja - zrak je kvalitetan). Pametni senzor za kvalitetu zraka ima mogućnost prepoznati najsitnije čestice prašine PM 2.5 - označava ultrasitne čestice manje od 2,5 mikrona (100 x tanje od vlasi ljudske kose).

Pomični IFD filter



U normalnim uvjetima, IFD filter nalazi se u prednjem dijelu isparivača. Kada se detektira loša kvaliteta zraka u prostoriji, uključuje se IFD filter koji se pomiče na gornji dio unutarnje jedinice kako bi prekrpio ulaz zraka. Zrak koji tada ulazi prolazi kroz statički elektricitet koji uništava i najsitnije nečistoće.

PREDNOSTI

Snažno pročišćavanje zraka



CADR omogućuje Haier klima uređajima da pročiste zrak u cijeloj prostoriji u roku od 15 minuta. Radi se o istoj izvedbi kao i kod profesionalnih pročišćivača zraka.

TUV / INTERTEK CERTIFIKAT



SUPER IFD STERILIZACIJA

Uklanja viruse i bakterije u prostoriji s učinkovitošću do 99,9%



TEHNOLOGIJA



Snažna apsorpcija statičkog elektriciteta

IFD filteri iznimno su učinkoviti zbog snažnog elektriciteta između čestica u zraku i unutarnje površine filtera.

Učinkovita sterilizacija

IFD filter visoko je učinkovit u hvatanju mikroba poput klica, bakterija, virusa, plijesni itd. Hvata do 99,9% čestica u zraku veličine 0,3 mikrona u promjeru, što je manje od svih virusa, bakterija i spora.

PREDNOSTI



Isporuka zdravog zraka

Eliminira bakterije i plijesan te učinkovito filtrira alergene iz zraka poput peludi, prašine (PM2.5 i PM 0.3)
Stopa sterilizacije: > 99%



Jednostavno čišćenje filtera

Nakon dužeg vremena korištenja, na filteru se nakuplja nečistoća. Umjesto kupnje novog filtera, IFD filter može se ponovno upotrijebiti.

SGS CERTIFIKAT



ANTIBAKTERIJSKA TEHNOLOGIJA

Self-Hygiene

Ionski srebrni premaz na isparivaču uz pomoć kojeg se dobiva 99,9% dezinficirani zrak. Ionsko srebro djeluje kao antiseptik zbog iona koji mogu prodrijeti kroz membranu bakterija.



TEHNOLOGIJA

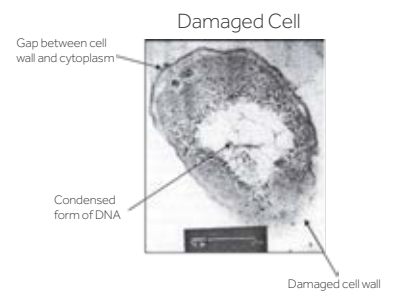
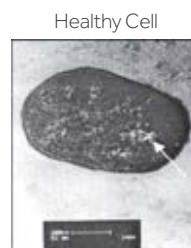
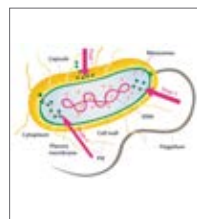
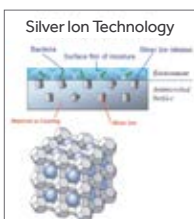

Nanočestice srebra

Plijesan i bakterije dio su zraka u zatvorenoj prostoriji. Njihova prisutnost narušava kvalitetu zraka, a mogu uzrokovati i bolesti. Strujanjem zraka kroz ventilator dio se nečistoća iz zraka može zaljepiti za elemente klima uređaja što pogoduje razvoju plijesni i bakterija.

Haier koristi nano čestice srebra koje kontinuirano otpuštaju nisku razinu iona srebra kako bi osigurao zaštitu od plijesni i bakterija.

PREDNOSTI



Ispuh zdravog zraka

Nano čestice srebra onemogućuju razvoj plijesni i bakterija unutar klima uređaja te osiguravaju ispuh čistog zraka u prostoriju.



Održavanje klima uređaja

Nanočestica srebra uništavaju 99,9% plijesni te onemogućuju razvoj bakterija. Idealno rješenje za pročišćavanje ustajalog zraka u prostoriji.

SGS CERTIFIKAT



UVC STERILIZACIJA

Ugrađeno UV LED svjetlo sterilizira zrak koji cirkulira klima uređajem. Učinkovito eliminira viruse i bakterije pri čemu isporučuje zdrav zrak u prostoriju.

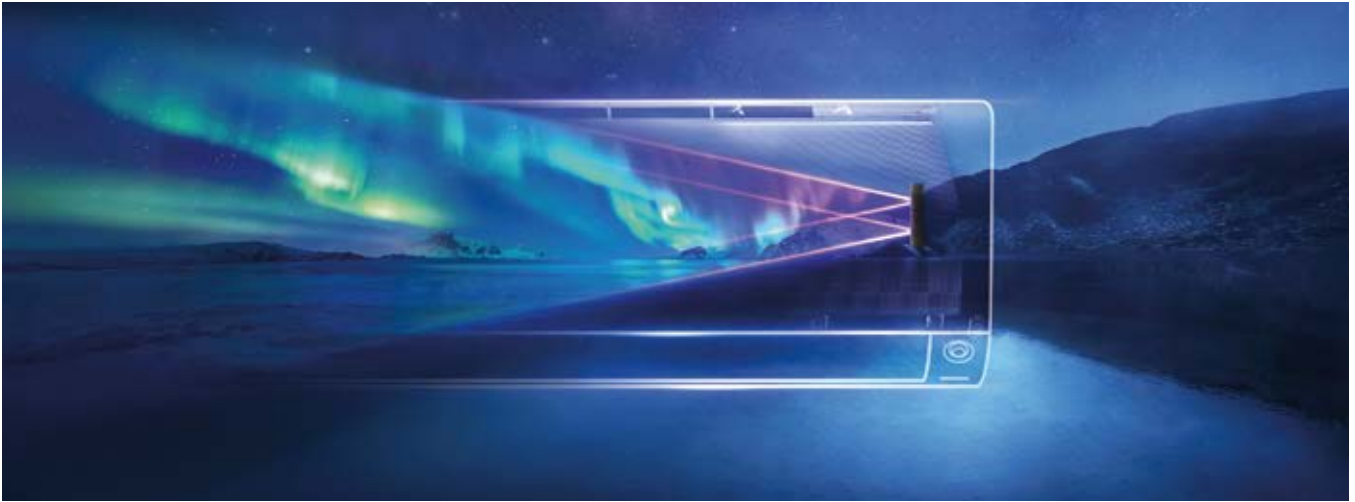

TEHNOLOGIJA

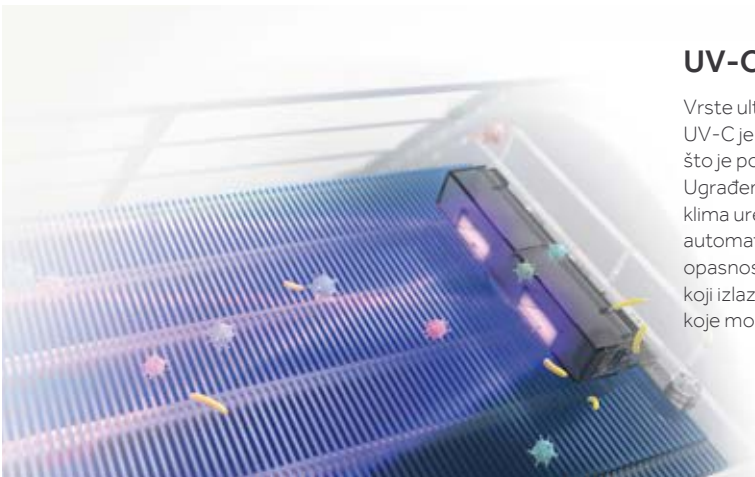

UV-C modul omogućuje do 99.9% čist zrak

Vrste ultraljubičastog zračenja: UVA, UVB i UV-C.

UV-C je energičnija valna duljina spektra u rasponu od 200-280 nm, što je posebno učinkovito u uništavanju genetske materije.

Ugrađeno LED UV svjetlo emitira zrake u blizini ulaza zraka u klima uređaj s desne na lijevu stranu. Zrak koji uđe u klima uređaj automatski je izravno izložen UV-C zrakama koje ubijaju sve opasnosti koje se nalaze u zraku poput virusa, bakterija i sl. Zrak koji izlazi iz klima uređaja 99,9% je pročišćen od svih opasnosti koje mogu ugroziti zdravlje.

PREDNOSTI



Sigurnost

LED UV uništava bakterije, viruse i sl. bez štetnih kemikalija i bez štetnog utjecaja na okoliš.

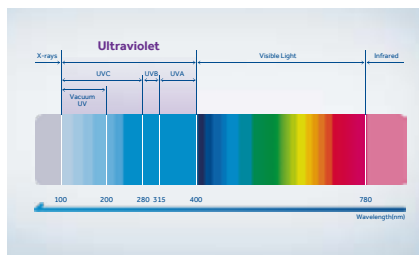

Učinkovita sterilizacija

Haier UVC sterilizacija koristi valnu duljinu između 265-275 nm, što je snažnije u uništavanju nevidljivih čestica u zraku koje su opasne za zdravlje

TEXCELL CERTIFIKAT



UVC PRO STERILIZACIJA

Inhibira razmnožavanje bakterija i sterilizira virus, razgrađuje molekulu vodika i kisika i stvara ionsku skupinu koja uništava bakterije i sterilizira viruse nakon kontakta.



TEHNOLOGIJA

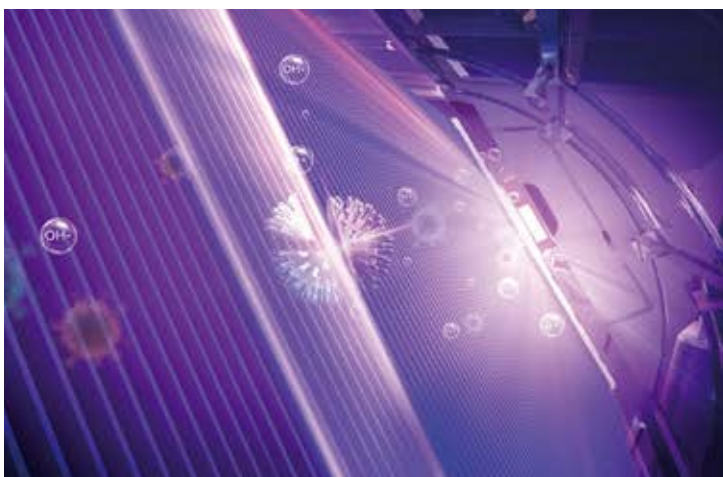

UVC Pro modul + ionizator

UVC Pro emitira UVC-zrake na ulazu zraka u klima uređaj. Direktno izlaganje UVC-C zrakama uništava strukturu DNA i RNA bakterija i virusa u zraku uzrokujući nemogućnost mikroorganizama da obavljaju vitalne stanične funkcije. Nova UVC Pro lampa stvara plazmu koja dodatno pospješuje sterilizaciju za zdraviji i čišći zrak u prostoriji.

PREDNOSTI



Ultimativna sterilizacija

UVC Pro istovremeno sterilizira unutarnju jedinicu i zrak u prostoriji. Uz pomoć UVC zraka i plazme, osigurana je vrhunska kvaliteta zraka i čistoća uređaja.

99.991%

Neovisnim testom dokazano je da novi UVC Pro modul inhibira SARS CoV 2 s 99,991% učinkovitosti.

TEXCELL CERTIFIKAT



ULTIMATIVNE PAMETNE FUNKCIJE

Budite povezani



Posljednjih godina bilježi se brzi razvoj telekomunikacija i IoT tehnologije. Malo je toga što ne možete učiniti jednim dodiranjem prsta na pametnim telefonima. Pametni uređaji postaju novi trend kućanstva u kojem je Haier preuzeo vodstvo. S pametnim funkcijama možete prilagoditi usluge svojim potrebama, kontrolirati svoj klima uređaj s bilo kojeg mjesta i u bilo koje vrijeme i još mnogo toga.

Haier je već 6 godina zaredom vodeći svjetski brend u kategoriji „pametnih “ klima uređaja s mogućnošću povezivanja.



WiFi kontrola



Eco senzor



Glasovne kontrole

WI-FI KONTROLA

Lako dostupna kontrola vašeg klima uređaja s bilo kojeg mjesta i bilo kada. „hOn” mobilna aplikacija budućnosti omogućava povezivanje svih kućanskih uređaja u vrhunsko SMART iskustvo.



TEHNOLOGIJA

WI-FI modul

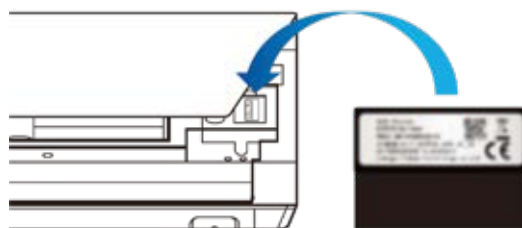
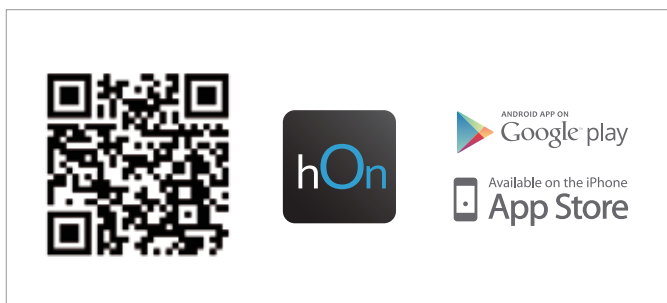

PREDNOSTI



Grupna kontrola

Upravljajte s više klima uređaja putem „hOn” aplikacije.



Pametni podsjetnici

Uključite pametne podsjetnike kako bi dobili obavijest o tome kada je vrijeme za čišćenje filtera klima uređaja..



Tjedni timer

Jednostavno namjestite tjedni raspored rada klima uređaja s jednim potezom na aplikaciji.



Upozorenje o pogrešci

Kôd pogreške prikazuje se ako klima uređaj ne radi ispravno.



Jednostavno upravljanje klima uređajem

Bez obzira gdje se nalazite, možete jednostavno upravljati s klima uređajem putem „hOn” aplikacije.



Prilagodite rad klima uređaja

Istražite opcije korištenja klima uređaja prema vašim zahtjevima.



Glasovne naredbe

Ugrađena glasovna kontrola omogućuje upravljanje s Haier klima uređajem putem glasovnih naredbi.



Godišnji odmor

S jednim klikom možete uključiti opciju Godišnji odmor.



Potrošnja el. energije

Putem „hOn” aplikacija pratite potrošnju Haier klima uređaja i uvjerite se u učinkovitost napredne tehnologije u segmentu uštede energije.

GLASOVNO UPRAVLJANJE

Iako imate kontrolu u Vašim rukama, nemate uvijek „treću“ ruku. Uživajte u pogodnostima pametnog upravljanja klima uređajem prilagođenog Vašim potrebama. Uz pomoć svog glasa uključite/isključite klima uređaj, promijenite način rada, podesite temperaturu ili provjerite trenutni status rada klima uređaja.



TEHNOLOGIJA



Vanjski glasovni modul

Modul u obliku utičnice povezuje vas s klima uređajem putem vašeg glasa. Kada ne možete pronaći daljinski upravljač, dovoljno je da samo govorite i bezbrižno upravljate svojim klima uređajem.

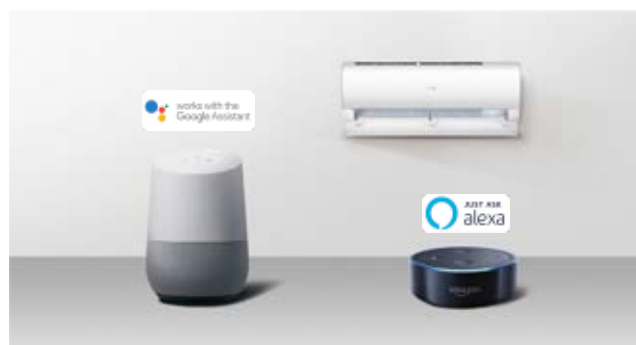

Integracija zvučnika treće strane

Putem zvučnika ili pametnog telefona, Google Assistant i Amazon Alexa omogućuju vam interakciju s klima uređajem. Glasovna kontrola funkcija temperature, načina rada itd.

PREDNOSTI



Intuitivno upravljanje uređajem hands-free

Nekoliko načina kako biste govorom s Alexom upravljali Haier pametnim klima uređajima:

Uključi/isključi klima uređaj.

Postavi klima uređaj na hlađenje/grijanje ili pametni način rada.

Koji način rada je postavljen na klima uređaju?

Da li je klima uređaj uključen/isključen?

Koja je temperatura postavljena na klima uređaju?

Postavi temperaturu klima uređaja na 20 °C.

ECO SENZOR

Senzor automatski detektira aktivnost osobe u sobi, a zatim prebacuje uređaj u način rada koji najbolje odgovara željenom ambijentu. Poboljšava energetska učinkovitost i korisničko iskustvo.



TEHNOLOGIJA

S dva integrirana modula, eko senzor istovremeno detektira dva područja s kutom do 120° i udaljenosti čak 8 metara. Senzor automatski analizira aktivnost osoba u prostoriji i zatim prilagođava protok zraka koji slijedi ili izbjegava korisnika ovisno o njegovim individualnim potrebama.

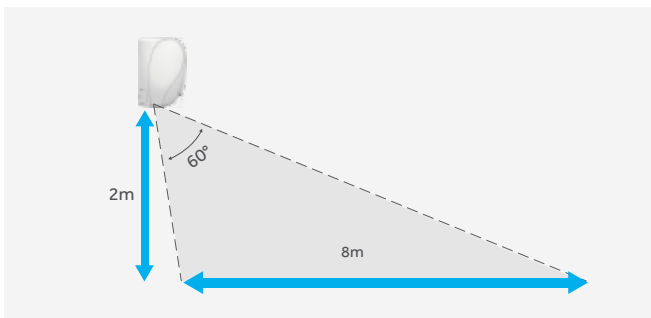

Vertikalno područje detekcije

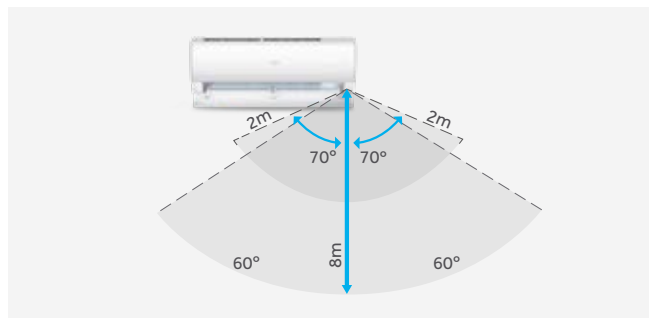

Horizontalno područje detekcije

PREDNOSTI

Ugodno iskustvo

Ukoliko je uključen **Follow** način rada, strujanje zraka pratit će kretanje korisnika u području A. Ukoliko je uključen **Avoid** način rada, strujanje zraka izbjegavat će korisnika u području B. Ukoliko senzor detektira korisnike u oba područja, klima uređaj će se automatski prebaciti u Swing način rada.

Ušteda energije

ECO senzor inteligentno prepoznaje položaj i kretanje ljudi u sobi. Kad je soba prazna, klima uređaj se za 20 minuta prebacuje u način uštede energije.

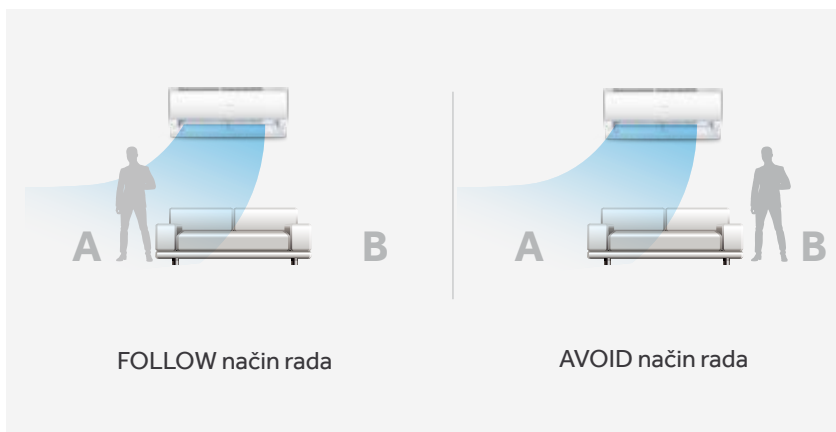

FOLLOW način rada

AVOID način rada

ULTIMATIVNI KOMFOR

Savršena udobnost u prostoru



Haier konstantno ulaže u razvoj inovativnih funkcija za komfor uz pomoć kojih zadovoljava i one najzahtjevnije korisnike.

PID inverter tehnologija omogućuje još brže postizanje željene temperature i preciznije održavanje temperature (tempomat za precizno održavanje željene temperature). Ispuh zraka unaprijeden je s trostrukim protokom i usmjerivačem koji generira jači i koncentriraniji ispuh zraka kako dospio u svaki kut prostorije. Haier klima uređaji već su dobro prepoznati po vrlo tihom radu 15 dB koji je tiši od šapata.



Hyper PCB



Inverter PLUS



Antikorozivna
zaštita



Coanda Plus
protok zraka



I Feel



Super tihi rad

HYPER PCB

Pružna konstantno, snažno hlađenje i optimizirani dizajn kako bi savladala fluktuacije napona i neočekivana oštećenja koja mogu dovesti do kvara klima uređaja.



TEHNOLOGIJA

Višeslojni konformni premaz

PC pločica je prekrivena višeslojnim zaštitnim konformnim premazom koji štiti od vlage, kemikalija, insekata i ekstremnih temperatura.

Kompaktan dizajn

Zbog svojih manjih dimenzija zauzima manji prostor u odnosu na standardne PC pločice. Minimiziran je utjecaj na učinkovitost rada izmjenjivača topline te je omogućen veći prostor za ostale komponente.



Materijal FR-4

Svojstva materijala FR-4 su vatro otpornost, odlično zadržavanje visokih mehaničkih karakteristika i svojstvo električnog izolatora, kako u suhim tako i u vlažnim uvjetima.

Smart Power Module

Ugrađeni senzor temperature visoke razlučivosti, kontrolira radnu učinkovitost kompresora za postizanje vrhunskih performansi hlađenja i grijanja.

PREDNOSTI

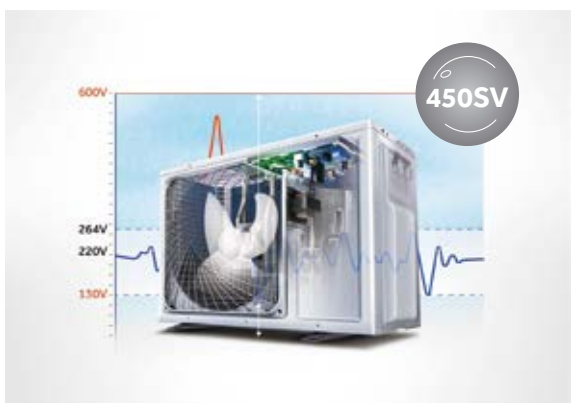

Stabilnija PC pločica

PC pločica radi stabilno između 130V-264V, a može početi na minimumu od 130V. Omogućuje stabilno hlađenje klima uređaja u ekstremnim uvjetima.

Izdržljivija PC pločica

Poseban dizajn i kvalitetniji konformni premaz štite komponente PC pločice od raznih elemenata koji joj skraćuju vijek trajanja.

INVERTER PLUS

Haier je razvio Inverter plus tehnologiju koja osigurava pametnu kontrolu klima uređaja za maksimalnu udobnost, pouzdanost i učinkovit rad jedinice.



TEHNOLOGIJA

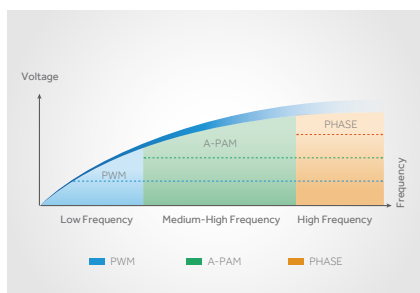

TLFM inverter tehnologija

Inverter koristi 3 različite kontrole napona za upravljanje optimalnom učinkovitosti u svakom frekventnom području.

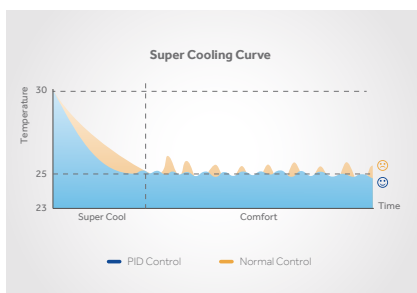

PID inverter tehnologija

Inverter maksimalno povećava radnu frekvenciju uređaja do postizanja željene temperature prostora, nakon toga stalno radi prilagodbe u stvarnom vremenu kako bi se ta temperatura i održavala.

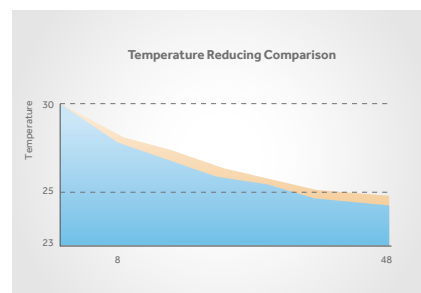

A-PAM inverter tehnologija

Inverterska tehnologija koja automatski podešava DC napon kompresora u skladu sa stvarnim opterećenjem istog kako bi se povećalo naponsko radno područje.

PREDNOSTI



Ušteda energije

Inverter plus tehnologija postiže visoku radnu učinkovitost u svim frekventnim područjima. Postiže se brži i jači efekt hlađenja i grijanja.

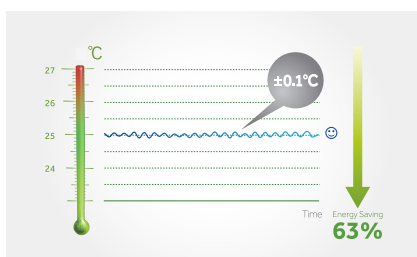

Vrhunska preciznost

Inverter Plus tehnologija puno brže postiže željenu temperaturu i zatim održava tu temperaturu s visokom preciznošću od $\pm 0,1^{\circ}\text{C}$



Pouzdan rad

Inverter Plus tehnologija prilagođava DC napon kompresora kako bi se postigao stabilan rad od 120V do 264V. Zbog toga korisnici Haier klima uređaja mogu nesmetano uživati u klimatiziranom prostoru bez obzira na varijacije napona na udaljenim područjima.

ANTIKOROZIVNA ZAŠTITA

Zaštitni antikorozivni premaz na isparivaču i vanjskoj jedinici klima uređaja sprječava nastanak korozije koja nastaje pod utjecajem kiše, vlage, slane vode i dr. Osigurava veću pouzdanost rada klima uređaja.



TEHNOLOGIJA



PREDNOSTI

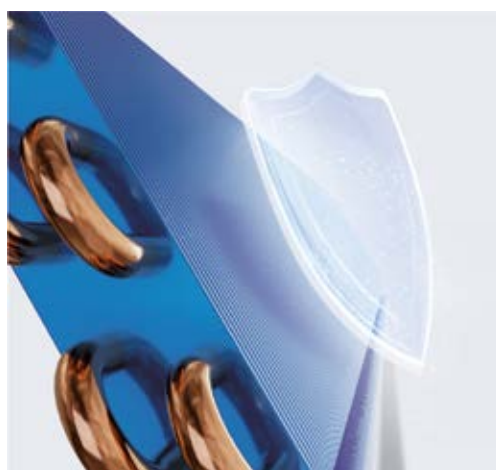

SGS CERTIFIKAT

Izdržljiviji klima uređaj

Antikorozivni premaz povećava izdržljivost klima uređaja te na taj način omogućava dugoročnu uštedu za korisnika.

Još pouzdaniji klima uređaj

Antikorozivni premaz sprječava oštećenja bakrenih cijevi i curenje plina i na taj način osigurava najbolju izvedbu rada klima uređaja.

COANDA PROTOK ZRAKA

Osigurava dalji, brži i jači ispuh zraka iz klima uređaja te pruža osjećaj proljetnog povjetarca ravnomjerno raspoređenog u cijeloj prostoriji. Coanda efekt generira lagano strujanje zraka i usmjerava ispuh iz klima uređaja prema stropu. Na taj način zrak cirkulira prostorijom i stvara savršeno ugodan ambijent.



TEHNOLOGIJA

Coanda plus protok zraka nastaje uz pomoć 3 dodatka na lameli koji ispušni zrak precizno usmjeravaju kako bi zrak što prirodnije cirkulirao po prostoriji.



Promjena smjera ispuha zraka

Primjenom dvoslojne strukture klapne stvara se jedinstvena Arhimedova spirala koja usmjerava hladno strujanje zraka prema stropu pod kutem od 35°.



Ubrzanje ispuha zraka

Strujanje zraka prolazi kroz optimalni tlačni ekspanzijski kanal koji je uži unutra, a širi izvana između dvoslojne strukture klapne gdje se javlja Venturijev efekt tako da se protok zraka trenutno oslobađa/ispuhuje velikom brzinom.



Centraliziran ispuh zraka

Protok zraka ispod klapne, apsorbiran podtlakom stvorenim većom brzinom strujanja zraka iznad njega, pridružuje se glavnom protoku zraka i čini ga još jačim.

PREDNOSTI



Stropno hlađenje

Kada je uključen način rada hlađenje, hladni zrak se usmjerava prema stropu pod kutem od 35° kako bi se izbjeglo izravno puhanje u osobe u prostoriji. Ohlađeni zrak se ravnomjerno i brže raspoređuje u prostoriji od stropa prema podu čime se postiže veći komfor za korisnika.



Podno grijanje

Kad je uključen način rada grijanje, topli zrak se usmjerava prema podu koji potom cirkulira i osigurava uravnoteženu temperaturu u prostoru.

I FEEL

Detektira sobnu temperaturu uz pomoć daljinskog upravljača bez obzira gdje se nalazili u prostoriji. Klima uređaj optimizira rad kako bi korisniku omogućio najbolje klimatizacijske uvjete.



TEHNOLOGIJA

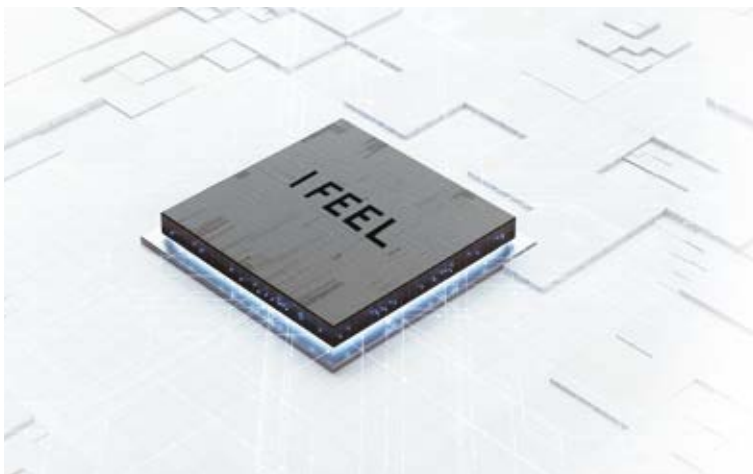

Izvedba klima uređaja može varirati u različitim uvjetima rada. Korisnik može osjećati nelagodu, ukoliko je sobna temperatura viša ili niža od očekivane.

Ugrađeni senzor temperature

Visoka rezolucija ugrađenog senzora, omogućava da daljinski upravljač može precizno pratiti temperaturu u prostoru.

Jednostavna kontrola

Klikom na tipku I Feel na daljinskom upravljaču, klima uređaj prima podatke o temperaturi prostora u realnom vremenu.

PREDNOSTI



Ugodno korisničko iskustvo

Funkcija optimizira radne uvjete klima uređaja kako bi isporučila klimatiziran zrak u potpunosti prilagođen potrebama korisnika.

ZVUK TIŠI OD ŠAPATA

Zamislite zvuk tiši od šapata. Klima uređaji Haier imaju novo rješenje kod funkcije tihog rada. Razina buke dovedena je do svega 15 dB. Za usporedbu, ljudski šapat mjeri se do 30 dB. Funkcije omogućavaju dodatno smanjenje razine buke klima uređaja. Ova funkcija pospešuje ugodu u prostoru, što je posebno potrebno kada se klima uređaj nalazi u spavaćoj sobi.



TEHNOLOGIJA

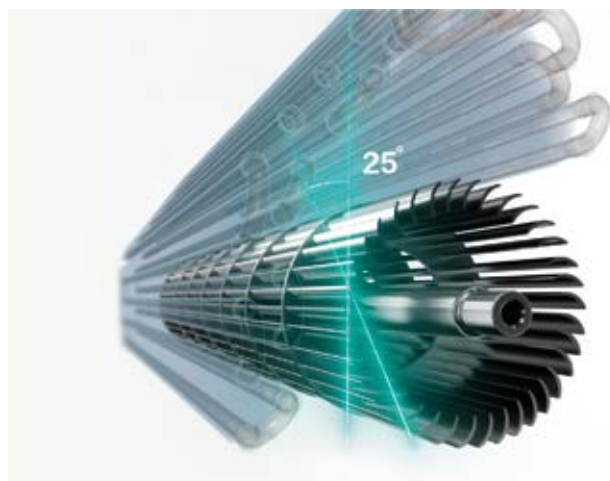

Optimizirani dizajn kućišta

Prostor gdje zrak ulazi je uvećan za 17%, prostor između isparivača i panela je dodatno proširen te je povećan otvor za izlaz zraka. Ova optimizacija pridonosi smanjenju razine buke kod rada klima uređaja.

Optimizirani ventilator unutarnje jedinice

Kut nagiba ventilatora optimiziran je na 25° kako bi se povećao protok zraka i minimalizirala buka rada ventilatora unutarnje jedinice.

Posebni sustav upravljanja

Posebni sustav upravljanja koristi A-PAM DC invertersku tehnologiju i DC motore, ovaj pristup pruža mogućnost visokog statičkog tlaka kako bi se minimalizirala buka u radu u unutarnje jedinice.

PREDNOSTI

Super tihi rad

Klima uređaj čiji rad je toliko tih da je nečujan i gotovo neprimjetan (15 dB).



75
dB(A)

10 metara
udaljenost od
autoputa



46
dB(A)

Vanjska jedinica
klima uređaja



20
dB(A)

Noć u prirodi



50
dB(A)

Normalna
govorna
konverzacija



30
dB(A)

Noć u pustinji



15
dB(A)

Šapatavi zrak

ULTIMATIVNA FLEKSIBILNOST

Fleksibilnost s lakoćom



Montaža bez puno napora, jednostavno i brzo održavanje i servisiranje bez demontaže isparivača, omogućuju veću učinkovitost na terenu u vrhuncu sezone.

Jednostavno održavanje i rastavljanje klima uređaja s lakim pristupom ventilatoru motora i kontrolnoj ploči.



Jednostavna
instalacija



Jednostavno
održavanje
i servisiranje



Super Match

FUNKCIONALNOST I UŠTEDA VREMENA

Jednostavna instalacija znači veću učinkovitost na terenu u vrijeme vrhunca sezone.

Jednostavna montaža, lako i brzo održavanje motora bez demontiranja isparivača.



TEHNOLOGIJA



Pozicioniranje na zid

Montažna ploča pomaže pri pozicioniranju klima uređaja na zid.



Nožica za lakši pristup

Jednostavni pristup i montiranje.



Dvosmjerni odvod kondenzata

Mogućnost priključenja odvoda kondenzata sa lijeve i desne strane za veću fleksibilnost kod montaže.



Širi prostor za cijevi

Ušteda vremena kod montaže.

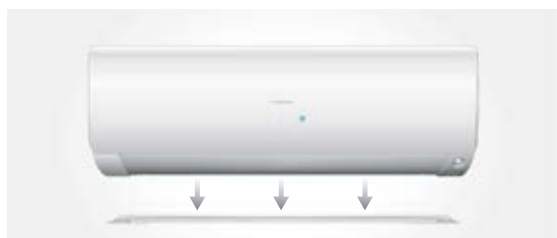

Odvojiv donji pokrov

Jednostavni pristup i montiranje.



Vanjski prekidač

Mogućnost uključivanja/isključenja klima uređaja bez upotrebe daljinskog upravljača.

JEDNOSTAVNA MONTAŽA, ODRŽAVANJE I SERVISIRANJE

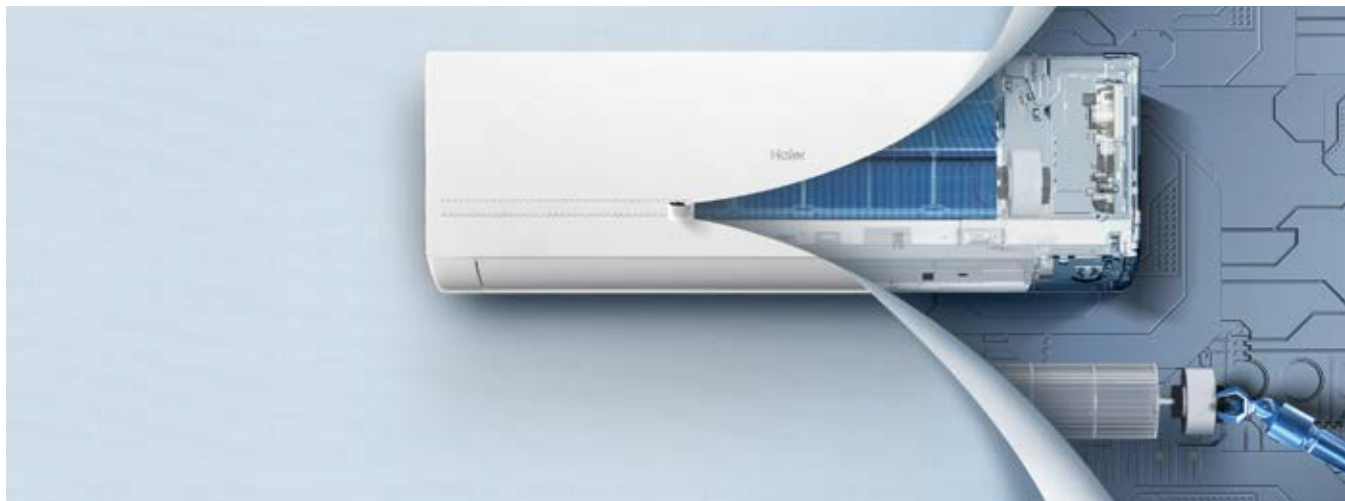

TEHNOLOGIJA

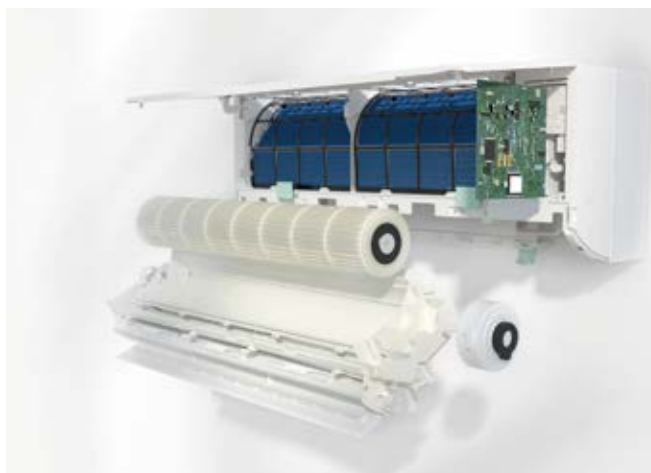

Rastavljanje PC pločice u 3 koraka

- Otvoriti prednji panel
- Otvoriti poklopac PC pločice
- Odspojiti terminale i izvaditi PC pločicu

Rastavljanje ventilatora i motora

- Otvoriti prednji panel
- Odvojiti donji poklopac
- Odspojiti terminale i izvaditi ventilator i motor

PREDNOSTI



80% brže
rastavljanje
PC pločice*



90% brže
rastavljanje
motora*



95% brže
rastavljanje
ventilatora*

SGS CERTIFIKAT



* Navedena tehnologija odnosi se na Expert model.

PREGLED FUNKCIJA

Ultimativno zdravlje



Frost Clean

Smrzava isparivač pomoću vlage iz zraka, te na taj način veže čestice nečistoće i otapanjem ih uklanja kroz odvod kondenzata, dok na ispuhu osigurava čist zrak.



56°C sterilizacija

Ubija bakterije i viruse zagrijavanjem isparivača na 56°C u trajanju od 30 minuta.



Self-higiene

Komponente kroz koje prolazi zrak zaštićene su premazom koji sadrži srebrne nanočestice. Eliminacija plijesni i bakterija iz zraka do 99,9%.



Easy to Clean

Nadogradnja Haier inovacija za zdrav zrak koja osigurava čist protok zraka iz klima uređaja. Jednostavno izvadite ventilator i filter za dubinsko čišćenje unutarnje jedinice.



Puri-Clean

Koristi napredni IFD filter za pročišćavanje koji uklanja sve vrste zagađivača i alergena iz zraka s učinkovitošću do 99,9%.



IFD sterilizacija

Apsorbira i uništava viruse i bakterije na način sličan ionskom pročišćivaču zraka, koristeći snažni elektricitet između čestica u zraku i unutarnje površine filtera za uklanjanje svih onečišćivača zraka. Učinkovitost: do 99%



UVC sterilizacija

Emitira UV zrake te na taj način sterilizira zrak koji prolazi kroz klima uređaj s učinkovitošću od 99,9%



UVC Pro

Sprječava razmnožavanje bakterija i sterilizira viruse. Razgradnjom kationa vodika i molekula kisika stvara ionsku skupinu koja inhibira bakterije i sterilizira virus nakon kontakta.



HAF Filter (3M Filter)

Koristi jaki elektrostatički naboj na površini filtera kako bi uklonio opasne mikro čestice, uključujući prašinu, viruse i bakterije te na taj način osigurava zdravije okruženje.



Blue Fin

Zbog hidrofilnog i anti korozivnog premaza, kondenzat otječe glatko i brzo. Učinkovitije uklanja mikro čestice poput prašine, virusa i bakterija te na taj način osigurava zdravije okruženje.

Ultimativne pametne funkcije



Glasovne kontrole

Uživajte u bežičnom glasovnom upravljanju svojim pametnim klima uređajem, kompatibilnim s digitalnim asistentima Amazon Alexa i Google Assistant.



WiFi kontrola

Preuzimanjem Haier hOn aplikacije na pametni uređaj (Apple ili Android), omogućuje se upravljanje i kontrola klima uređaja s bilo koje lokacije i bilo kada.



Eco senzor

Detektira stanje u prostoru, te ljudsku aktivnost u realnom vremenu, te prilagođava način rada kako bi postigao najbolju energetska učinkovitost i udobnost za korisnike.

Ultimativni komfor



Coanda Plus protok zraka

Osigurava dalji, brži i jači ispuh zraka iz klima uređaja, kako bi zrak bio jednakomjerno raspodijeljen po cijeloj prostoriji.



A-PAM Control

Automatski prilagođava napon uređaja ovisno o opterećenju kompresora, te na taj način postiže veću uštedu.



PID Control

Maksimizira radnu frekvenciju kako bi u što kraćem roku postigao željenu temperaturu prostora, a nakon toga u realnom vremenu stalno prilagođava frekvenciju uređaja kako bi održavao željenu temperaturu u prostoriji.



Turbo hlađenje

Poseban program omogućava motoru rad na većim frekvencijama. Omogućava korisnicima uživanje u željenoj temperaturi u znatno kraćem vremenu.



Ispuh dugog dometa

Unutarnja jedinica sa boljim motorom, optimiziranim ventilatorom i zračnim kanalom.



Jaki ispuh

S poboljšanim ventilatorom i zračnim kanalom, klima uređaj isporučuje 25% više volumena zraka.



Hyper PCB

Raspon radnog napona je 130V-264V. Može se pokrenuti na minimalno 130V i izdržati maksimalni skok napona od 450SV.



Antikoroziivna zaštita

Zaštita klima uređaja od oštećenja izazvanih ekstremnim uvjetima u priobalju gdje je visoka koncentracija vlage u zraku, slane vode, kemikalija i kiselina. Osigurava veću pouzdanost rada klima uređaja.

PREGLED FUNKCIJA

Ultimativni komfor



Topli start

Prilikom grijanja ili promjene načina rada iz hlađenja u grijanje, klima uređaj ne ispuhuje hladni zrak u prostor.



-30°C grijanje

Visokoučinkovito grijanje pri vrlo niskim temperaturama. Osigurava stabilan učinak grijanja čak i u ekstremno hladnim uvjetima (temperature do -30°C).



-20°C grijanje

Osigurava jaki učinak grijanja u hladnim zimama zbog rotari kompresora, DC motora, optimizirane donje ploče, električnog grijača i specijalnog programa.



-15°C grijanje

Osigurava jaki učinak grijanja u hladnim zimama zbog rotari kompresora.



-10°C grijanje

Radi pri niskim temperaturama s visoko frekventnim rotari kompresorom, optimiziranim rashladnim sistemom i posebnim programom za odmrzavanje.



DC motor

Osigurava pouzdan rad uređaja s većom uštedom energije i nižom razinom buke.



DC kompresor

Reducira gubitak energije i maksimizira ulaz kako bi postigao što veću energetska učinkovitost.



Pametno odmrzavanje

Radi samo po potrebi zbog uštede energije i omogućava bolji rad uređaja smanjenjem vremena odmrzavanja.



5 stupanjski ventilator unutarnje jedinice

Radi u jakoj/visokoj/srednjoj/niskoj/tihoj brzini rada, te daje korisniku veći izbor mogućih brzina ispuha.



Dupla horizontalna krilca

Podržava strujanje zraka u više smjerova i poboljšava korisničko iskustvo.



Automatsko vertikalno strujanje zraka

Pomicanjem horizontalnih krilaca, usmjerava zrak vertikalno u više mogućih kutova.



3-minutna zaštita

Pomaže kompresoru izbjegavanje naglih izmjena opterećenja te mu time produžuje životni vijek.



Auto restart

Ukoliko dođe do nestanka struje, uređaj nastavlja rad po prethodno postavljenim postavkama.



Široki raspon radnog napona

Omogućava inverter klima uređaju rad od 150V-264V



88 ekran

U realnom vremenu prikazuje temperaturu prostorije ili željenu temperaturu.



Auto mod

Odabire automatski hlađenje ili grijanje, ovisno o temperaturi koja je zadana.



Integrirana struktura

Kombinira donji dio kućišta, kadicu odvoda kondenzata i cjelokupni oklop klima uređaja kako bi se smanjile vibracije i poboljšala pouzdanost.



10°C održavanje temperature

Kada temperatura u prostoru padne ispod 10°C, uključuje se grijanje kako bi se cijevi i instalacije zaštitile od smrzavanja.



1 Watt standby

Spušta potrošnju u stanju mirovanja sa 8W na samo 1W, optimizirajući rad programa.



Integriran poklopac ventila

Štiti blok terminal za priključne žice kao i priključne ventile te poboljšava estetiku vanjske jedinice.



Vanjski 7-stupanjski ventilator

Optimizira rad izmjenjivača temperature pomoću kontroliranih senzora, te na taj način poboljšava energetska učinkovitost.



Super tihi rad

Optimiziran rad ventilatora i motora pruža korisniku potpuni mir i tišinu.



Precizno odvlaživanje

Kontrolira razinu vlage u zraku kako bi održao zrak čistim i ugodnim.



Precizna kontrola temperature

Omogućuje podešavanje temperature s preciznošću od 0,5°C. Postiže se bolji komfor i veća ušteda energije.

PREGLJED FUNKCIJA

Ultimativni komfor



Funkcija isušivanja

Automatski prilagođava brzinu ventilatora prema temperaturi u prostoriji, kako bi se postiglo blago ili snažno isušivanje.



3D ispuh zraka

Omogućuje ugodno strujanje zraka do svih kutova prostorije, konstantnim pomicanjem krilca u horizontalnom i vertikalnom smjeru.



Inteligentan zrak (Low wind)

Usmjerava strujanje zraka prema gore u modu hlađenja, te prema dolje u modu grijanja, čime postiže bolji klimatizacijski učinak.
LOW WIND – Brzo postizanje željene temperature i održavanje bez propuha.



Ugodan san

Pružna maksimalan komfor i uštedu energije za miran san.



I Feel

Haier klima uređaj može točno detektirati i kontrolirati sobnu temperaturu u prostoriji u kojoj se nalazi upravljač.

Ultimativna fleksibilnost



Specifikacije pozicioniranja

Pomaže pri učvršćivanju montažne ploče i omogućava preciznu montažu klima uređaja.



Produžena montažna nožica

Laka montaža i održavanje klima uređaja zbog većeg operativnog prostora.



Jednostavan pristup kontrolnoj ploči

Pojednostavljuje pristup i održavanje kontrolne ploče bez rastavljanja kućišta.



Širi prostor cijevi

Štedi vrijeme instalacije većim prostorom za spajanje cijevi i žica.



Jednostavan pristup motoru ventilatora

Pojednostavljuje demontažu i održavanje, bez rastavljanja isparivača.



Odvojiv donji pokrov

Lako otvaranje dna kućišta bez odvijača, radi lakšeg spajanja cijevi i žica.



Jednostavno održavanje i servis

Optimizira strukturu unutarnje jedinice klima uređaja pojednostavljenim rastavljanjem osnovnih komponenti uključujući PC pločicu, motor i ventilator, čineći održavanje i čišćenje lakšim nego ikad prije.



Samo dijagnoza

Prikazuje Error kôd na LED ekranu unutarnje jedinice kako bi se olakšalo i ubrzalo održavanje.



Super match

Slobodno kombiniranje unutarnjih i vanjskih jedinica, radi lakšeg snalaženja u prodaji, analizama i evidenciji.



On-Off Card





























Omogućuje dodatnu uštedu i kontrolu nad klima uređajima koji se nalaze u hotelskim sobama ili apartmanima. Omogućava isključivanje/uključivanje klima uređaja s vanjskim kontaktom - ulazna vrata ili kod otvaranja ili zatvaranja prozora.



Central Control

Haier klima uređaji mogu se spojiti na centralizirani sustav upravljanja s više HVAC jedinica. Pametno upravljanje klima uređajem pojedinačno, grupno ili u zonama objekta.

PREDNOSTI

	Kategorije & funkcije		Jade	Expert - Nordic	Expert
Ultimativno zdravlje	Frost-Clean		●	●	●
	56°C sterilizacija		●	●	●
	Self-higiene		●		
	Easy to Clean			●	●
	Puri-Clean		●		
	IFD sterilizacija		●		
	UVC sterilizacija				
	UVC pro			●	●
	HAF Filter (3M Filter)			○	○
	Blue Fin		●	●	●
Ultimativne pametne funkcije	Glasovne kontrole		●	●	●
	WiFi kontrola		●	●	●
	Eco senzor		●	●	●
Ultimativni komfor	A-PAM Control		●	●	●
	PID Control		●	●	●
	Turbo hlađenje		●	●	●
	Ispuh dugog dometa		18k		18k
	Jaki ispuh		●	●	●
	Hyper PCB		●	●	●
	Anti-Corrosion		●	●	●
	Topli start		●	●	●
	-20°C grijanje		●	●	●
	-15°C grijanje		●	●	●
	-10°C grijanje		●	●	●
	DC motor		●	●	●
	DC kompresor		●	●	●
	Pametno odmrzavanje		●	●	●
	5 stupanjski ventilator unutarnje jedinice		●	●	●
	Dupla horizontalna krilca				18k/24k

Haier klima uređaji

Flexis Plus	Pearl	Tundra Plus	Tide Plus
●	●	●	●
●	●		
●	●		
○	○	○	○
●	●	●	●
●	●	●	●
●	●	●	●
●			
●	●	●	●
●	●	●	●
●	●	●	●
18k/24k	18k/24k	18k/24k	18k/24k
●	●	●	●
●	●	●	●
●	●	●	●
●	●	●	●
●			
●	●	●	●
●	●	●	●
●	●	●	●
●	●	●	●
●	●	●	●
●	●	●	●
●	●	●	●
18k/24k			

● : Standard ○ : Optional











PREDNOSTI

Kategorije & funkcije			Jade	Expert - Nordic	Expert
Ultimativni komfor	Automatsko vertikalno strujanje zraka		●	●	●
	3 minutna zaštita		●	●	●
	Auto restart		●	●	●
	Široki raspon radnog napona		●	●	●
	88 ekran		●	●	●
	Auto mod		●	●	●
	Integrirana struktura		●	●	●
	10° C grijanje		●	●	●
	1 Watt standby		●	●	●
	Integriran poklopac ventila		●	●	●
	Vanjski 7-stupanjski ventilator		●	●	●
	Coanda Plus Airflow			●	●
	Super tihi rad		●	●	●
	Precizno odvlaživanje		●		
	Precizna kontrola temperature		●		
	Funkcija isušivanja		●	●	●
	3D ispuh zraka		●	●	●
	Inteligentan zrak		●	●	●
	Ugodan san		●	●	●
I Feel			●	●	
Ultimativna fleksibilnost	Specifikacije pozicioniranja		●	●	●
	Produžena montažna nožica		●	●	●
	Jednostavan pristup kontrolnoj ploči		●	●	●
	Širi prostor cijevi		●	●	●
	Jednostavan pristup motoru ventilatora		●	●	●
	Odvojiv donji dio unutarnje jedinice		●	●	●
	Jednostavno održavanje i servis		●	●	●
	Samo dijagnoza		●	●	●
	Super kombinacija		●		●
	On-Off Card		○	○	○
	Central Control		●	●	●

Haier klima uređaji

Flexis Plus	Pearl	Tundra Plus	Tide Plus
●	●	●	●
●	●	●	●
●	●	●	●
●	●	●	●
●	●	●	●
●	●	●	●
●	●	●	●
●	●	●	●
●	●	●	●
●	●	●	●
●	●	●	●
●	●	●	●
●	●	●	●
●	●	●	●
●	●	●	●
●	●	●	●
●	●	●	●
●	●	●	●
●	●	●	●
●	●	●	●
●	●	●	●
●	●	●	●
●	●	●	●
●	●	●	●
●	●	●	●
●	●	●	●
●	●	●	●
●	●	●	●
●	●	●	●
●	●	●	●
●	●	●	●
●	●	●	●
●	●	●	●
●	●	●	●
○	○	○	○
●	●	●	●

PREGLED MODELA

Kategorija	Naziv modela		Remote Controller
INVERTER	Jade		
	Expert - Nordic		
	Expert		
	Flexis Plus		
	Pearl		
	Tundra Plus		
	Tide Plus		

Haier klima uređaji

9K	12K	18K	24K
•	•	•	
•	•		
•	•	•	
•	•	•	•
•	•	•	•
•	•	•	•
•	•	•	•



■ PREDNOSTI



Puri-Clean

Koristi napredni IFD filter za pročišćavanje koji uklanja sve vrste zagađivača i alergena iz zraka s učinkovitošću do 99.9%.



56°C sterilizacija

Uništava bakterije i viruse zagrijavanjem isparivača na 56°C u trajanju od 30 minuta.



Self-hygiene

Komponente kroz koje prolazi zrak zaštićene su premazom koji sadrži srebrne nanočestice. Eliminacija plijesni i bakterija iz zraka do 99.9%.



Puri-Clean



Frost Clean



Precizno odvlaživanje



Super tihi rad



Wi-Fi kontrola (hOn)



Jednostavna instalacija



3D ispuh zraka



ECO senzor

Popis svih funkcija za navedeni model nalazi se na stranicama 34. – 39.

Model	Unutarnja		AS25S2SJ1FA-3	AS35S2SJ1FA-3	AS50S2SJ1FA-3
	Vanjska		1U25MECFRA-3	1U35MECFRA-3	1U50JECFRA-3
Hlađenje					
Kapacitet	Nominal (Min-Max)	Btu/h	8870(3410-13650)	11940(3410-13650)	17740(4770-20470)
	Nominal (Min-Max)	kW	2.6(1.0-4.0)	3.5(1.0-4.0)	5.2(1.4-6.0)
Energetska efikasnost	SEER/EER		8.75/4.5	8.75/4.4	7.50/3.68
Energetski razred			A+++	A+++	A++
Pdesign kapacitet		kW	2.6	3.5	5.2
Snaga električnog priključka	Nominal (Min-Max)	kW	0.57(0.3-1.25)	0.79(0.3-1.35)	1.4(0.3-2.1)
Godišnja potrošnja energije		kWh/a	104	140	243
Temperaturni raspon rada	Min-Max	°C	-10-43°C (out)	-10-43°C (out)	-10-43°C (out)
Grijanje					
Kapacitet	Nominal (Min-Max)	Btu/h	10920(3750-18420)	14330(4430-19790)	20470(4770-23540)
Kapacitet	Nominal (Min-Max)	kW	3.2(1.1-5.4)	4.2(1.3-5.8)	6.0(1.4-6.9)
Energetska efikasnost	SCOP/COP (Mild)		5.1/4.8	5.1/4.7	4.6/4.0
	SCOP (Warm/Cold)		6.2/-	6.2/-	5.6/-
Energetski razred	Mild/Warm/Cold		A+++/A+++/-	A+++/A+++/-	A++/A+++/-
Pdesign (-10°C)		kW	2.6	2.65	4.6
Snaga električnog priključka	Nominal (Min-Max)	kW	0.66(0.3-1.85)	0.89(0.3-1.85)	1.5(0.3-2.5)
Godišnja potrošnja energije		kWh/a	714	727	1400
Temperaturni raspon rada		°C	-20-24°C (out)	-20-24°C (out)	-20-24°C (out)
Napajanje	Ph/V/Hz		1/220-240/50	1/220-240/50	1/220-240/50
	Pozicija		Vanjska jedinica	Vanjska jedinica	Vanjska jedinica
Unutarnja jedinica					
Neto dimenzije	Š / D / V	mm	923/215/320	923/215/320	1050/235/350
Dimenzije sa ambalažom	Š / D / V	mm	1032/318/418	1032/318/418	1160/347/455
Neto/bruto težina		kg	12/15.2	12/15.2	14.9/18.9
Protok zraka	Max	m ³ /h	550	600	900
Razina buke - zvučna snaga	Hlađenje (Hi/Mid/Lo/So)	dB(A)	36/32/29/15	37/33/30/16	41/37/33/28
	Grijanje (Hi/Mid/Lo/So)	dB(A)	36/32/29/15	37/33/30/16	41/37/33/28
Odvlaživanje		10-3m ³ /h	1.2	1.6	2
Vanjska jedinica					
Neto dimenzije	Š / D / V	mm	800/275/553	800/275/553	820/338/614
Dimenzije sa ambalažom	Š / D / V	mm	908/405/625	908/405/625	993/413/685
Neto/bruto težina		kg	29.8/33.6	29.8/33.6	37.8/41.5
Protok zraka	Max	m ³ /h	2000	2000	2500
Razina buke - zvučna snaga	Hi	dB(A)	48	49	51
Radna struja	Max	A	8	8	11.1
Vrsta radne tvari	R32		R32	R32	R32
Količina radne tvari	R32	g	740	740	950
Promjeri cijevi	Tekućinski	mm	6.35	6.35	6.35
	Plinski	mm	9.52	9.52	12.7
	Max. dozvoljena duljina	m	20/10	20/10	25/15
	Max. duljina cjevovoda bez nadopune	m	7	7	7
	Nadopuna po dodatnom metru	g/m	20	20	20
Razmak između nogica - informacije se nalaze u zadnjem dijelu kataloga.					



reddot winner 2022



Adapter za žičani kontroler



Žičani kontroler (opcija)



■ PREDNOSTI



UVC Pro

Sprječava razmnožavanje bakterija i sterilizira viruse. Razgradnjom kationa vodika i molekula kisika stvara ionsku skupinu koja inhibira bakterije i sterilizira virus nakon kontakta.



3D ispuh zraka

Omogućuje ugodno strujanje zraka do svih kutova prostorije, konstantnim pomicanjem krilca u horizontalnom i vertikalnom smjeru.



-30°C grijanje

Visokoučinkovito grijanje pri vrlo niskim temperaturama. Osigurava stabilan učinak grijanja čak i u ekstremno hladnim uvjetima (temperature do -30°C).



56°C sterilizacija



I Feel



Frost Clean



Coanda Plus protok zraka



ECO senzor



Wi-Fi kontrola (hOn)



On-Off card



Easy to Clean

Popis svih funkcija za navedeni model nalazi se na stranicama 34. – 39.

Expert Nordic

Model	Unutarnja		AS25XCHHRA-NR	AS35XCHHRA-NR
	Vanjska		1U25KEHFRA-NR	1U35KEHFRA-NR
Hlađenje				
Kapacitet	Nominal (Min-Max)	Btu/h	8870 (3410-11940)	11940(3410-15010)
	Nominal (Min-Max)	kW	2.6	3.5
Energetska efikasnost	SEER/EER		8.5	8.5
Energetski razred			A+++	A+++
Pdesign kapacitet		kW	2.6	3.5
Snaga električnog priključka	Nominal (Min-Max)	kW	0.58	0.82
Godišnja potrošnja energije		kWh/a	107	144
Temperaturni raspon rada	Min-Max	°C	-20-43°C(out)	-20-43°C(out)
Grijanje				
Kapacitet	Nominal (Min-Max)	Btu/h	10910(3410-25240)	14330(4430-26950)
Kapacitet	Nominal (Min-Max)	kW	3.2(1.0-7.4)	4.2(1.3-7.9)
Energetska efikasnost	SCOP/COP (Mild)		5.1	5.1
	SCOP (Warm/Cold)		5.1/3.8	5.1/3.8
Energetski razred	Mild/Warm/Cold		A+++/A++/A	A+++/A++/A
Pdesign kapacitet (-10°C)		kW	3.0	3.6
Snaga električnog priključka	Nominal (Min-Max)	kW	0.76	1.0
Godišnja potrošnja energije		kWh/a	824	988
Temperaturni raspon rada		°C	-30-24°C(out)	-30-24°C(out)
Napajanje	Ph/V/Hz		1/230/50	1/230/50
	Pozicija		Vanjska jedinica	Vanjska jedinica
Unutarnja jedinica				
Neto dimenzije	Š/D/V	mm	895/236/313	895/236/313
Dimenzije sa ambalažom	Š/D/V	mm	964/386/316	964/386/316
Neto/bruto težina		kg	12.4/14.8	12.4/14.8
Protok zraka	Max	m³/h	750	810
Razina buke - zvučna snaga	Hlađenje (Hi/Mid/Lo/So)	dB(A)	42/32/24/18	43/33/24/18
	Grijanje (Hi/Mid/Lo/So)	dB(A)	42/32/24/18	43/33/24/18
Odvlaživanje		10-3m³/h	1.2	1.6
Vanjska jedinica				
Neto dimenzije	Š/D/V	mm	820/305/643	820/305/643
Dimenzije sa ambalažom	Š/D/V	mm	940/390/697	940/390/697
Neto/bruto težina		kg	35.7/38.5	35.7/38.5
Protok zraka	Max	m³/h	3200	3200
Razina buke - zvučna snaga	Hi	dB(A)	49	50
Radna struja	Max	A	10.9	11.36
Vrsta radne tvari	R32		R32	R32
Količina radne tvari	R32	g	1100	1100
Promjeri cijevi	Tekućinski	mm	6.35	6.35
	Plinski	mm	9.52	9.52
	Max. dozvoljena duljina	m	20/10	20/10
	Max. duljina cjevovoda bez nadopune	m	7	7
	Nadopuna po dodatnom metru	g/m	20	20
Razmak između nogica - informacije se nalaze u zadnjem dijelu kataloga.				



reddot winner 2022



Adapter za žičani kontroler



Žičani kontroler (opcija)



■ PREDNOSTI



UVC Pro

Sprječava razmnožavanje bakterija i sterilizira viruse. Razgradnjom kationa vodika i molekula kisika stvara ionsku skupinu koja inhibira bakterije i sterilizira virus nakon kontakta.



Easy to Clean

Inovacija za čist zrak koja omogućuje jednostavno vađenje ventilatora i filtera za dubinsko čišćenje klima uređaja.



56°C sterilizacija

Uništava bakterije i viruse zagrijavanjem isparivača na 56°C u trajanju od 30 minuta.



ECO senzor



Wi-Fi kontrola (hOn)



On-Off card



3D ispuh zraka



Jednostavna instalacija



I Feel



Frost Clean



Coanda Plus protok zraka

Popis svih funkcija za navedeni model nalazi se na stranicama 34. – 39.

Model	Unutarnja		AS25XCAHRA	AS35XCAHRA	AS50XCAHRA
	Vanjska		1U25S2SM1FA-2	1U35S2SM1FA-2	1U50S2SJ2FA-2
Hlađenje					
Kapacitet	Nominal (Min-Max)	Btu/h	9550 (2730-10920)	11940 (3410-13650)	17064 (4770-18770)
	Nominal (Min-Max)	kW	2.8 (0.8-3.2)	3.5 (1.0-4.0)	5.0 (1.4-5.5)
Energetska efikasnost	SEER/EER		8.8/4.3	8.5/4.00	6.6/3.4
Energetski razred			A+++	A+++	A++
Pdesign kapacitet		kW	2.8	3.5	5
Snaga električnog priključka	Nominal (Min-Max)	kW	0.65(0.2-1.2)	0.87(0.3-1.4)	1.47(0.5-2.0)
Godišnja potrošnja energije		kWh/a	111	144	265
Temperaturni raspon rada	Min-Max	°C	-20-43°C(out)	-20-43°C(out)	-20-43°C(out)
Grijanje					
Kapacitet	Nominal (Min-Max)	Btu/h	10920 (2730-14330)	14330 (3410-17740)	19110 (5800-21160)
Kapacitet	Nominal (Min-Max)	kW	3.2 (0.8-4.2)	4.2 (1.0-5.2)	6.0 (1.7-6.2)
Energetska efikasnost	SCOP/COP (Mild)		4.8/4.2	4.75/4.05	4.3/3.7
	SCOP (Warm/Cold)		5.1/-	5.1/-	5.1/-
Energetski razred	Mild/Warm/Cold		A++/A+++/-	A++/A+++/-	A++/A+++/-
Pdesign kapacitet (-10°C)		kW	2.5	2.8	4.6
Snaga električnog priključka	Nominal (Min-Max)	kW	0.76(0.3-1.5)	1.04(0.5-1.6)	1.51(0.52-2.3)
Godišnja potrošnja energije		kWh/a	737	825	1498
Temperaturni raspon rada		°C	-20-24°C(out)	-20-24°C(out)	-20-24°C(out)
Napajanje	Ph/W/Hz		1/220-240/50	1/220-240/50	1/220-240/50
	Pozicija		Vanjska jedinica	Vanjska jedinica	Vanjska jedinica
Unutarnja jedinica					
Neto dimenzije	Š/D/V	mm	895/236/313	895/236/313	895/236/313
Dimenzije sa ambalažom	Š/D/V	mm	964/316/386	964/316/386	964/316/386
Neto/bruto težina		kg	11.3/14	11.3/14	11.6/14.2
Protok zraka	Max	m³/h	730	800	880
Razina buke - zvučna snaga	Hlađenje (Hi/Mid/Lo/So)	dB(A)	39/32/25/16	40/33/26/17	45/37/29/20
	Grijanje (Hi/Mid/Lo/So)	dB(A)	39/32/25/16	40/33/26/17	45/37/29/20
Odvlaživanje		10-3m³/h	1.2	1.6	2
Vanjska jedinica					
Neto dimenzije	Š/D/V	mm	800/275/553	800/275/553	820/305/643
Dimenzije sa ambalažom	Š/D/V	mm	902/375/607	902/375/607	940/390/697
Neto/bruto težina		kg	27.6/30.4	30/32.9	35.7/38.5
Protok zraka	Max	m³/h	2300	2400	3000
Razina buke - zvučna snaga	Hi	dB(A)	48	49	50
Radna struja	Max	A	6.8	7.2	10.7
Vrsta radne tvari	R32		R32	R32	R32
Količina radne tvari	R32	g	630	780	1100
Promjeri cijevi	Tekućinski	mm	6.35	6.35	6.35
	Plinski	mm	9.52	9.52	12.7
	Max. dozvoljena duljina	m	20/10	20/10	25/15
	Max. duljina cjevovoda bez nadopune	m	7	7	7
	Nadopuna po dodatnom metru	g/m	20	20	20

Razmak između nogica - informacije se nalaze u zadnjem dijelu kataloga.



Adapter za žičani kontroler



Žičani kontroler (opcija)



■ PREDNOSTI



UVC sterilizacija

Emitira UV zrake te na taj način sterilizira zrak koji prolazi kroz klima uređaj s učinkovitošću od 99.9%.



56°C sterilizacija

Uništava bakterije i viruse zagrijavanjem isparivača na 56°C u trajanju od 30 minuta.



ECO senzor

Detektira stanje u prostoru, te ljudsku aktivnost u realnom vremenu, te prilagođava način rada kako bi postigao najbolju energetska učinkovitost i udobnost za korisnike.

Popis svih funkcija za navedeni model nalazi se na stranicama 34. – 39.



Frost Clean



ECO senzor



Jednostavna instalacija



Super tihi rad



Wi-Fi kontrola (hOn)



I Feel



3D ispuh zraka



Širi prostor cijevi

Flexis Plus

Haier

2,6 kW

3,5 kW

5,2 kW

7,0 kW

Model	Unutarnja		AS25S2SF1FA-BH AS25S2SF1FA-S AS25S2SF1FA-WH	AS35S2SF1FA-BH AS35S2SF1FA-S AS35S2SF1FA-WH	AS50S2SF1FA-BH AS50S2SF1FA-WH	AS71S2SF1FA-BH AS71S2SF1FA-WH
	Vanjska		1U25S2SM1FA-2	1U35S2SM1FA-2	1U50S2S2FA-2	1U71S2SR2FA
Hlađenje						
Kapacitet	Nominal (Min-Max)	Btu/h	8870 (2730-10920)	11940 (3410-13650)	17740 (4770-20470)	23890 (7510-25600)
	Nominal (Min-Max)	kW	2.6 (0.8-3.2)	3.5 (1.0-4.0)	5.2 (1.4-6.0)	7.0 (2.20-7.70)
Energetska efikasnost	SEER/EER		8.5/4.00	8.5/4.00	7.2/3.60	7.1/3.23
Energetski razred			A+++	A+++	A++	A++
Pdesign kapacitet		kW	2.6	3.5	5.2	7.0
Snaga električnog priključka	Nominal (Min-Max)	kW	0.65 (0.20-1.20)	0.87(0.30-1.50)	1.4 (0.5-2.0)	2.17 (0.7-2.5)
Godišnja potrošnja energije		kWh/a	107	144	253	345
Temperaturni raspon rada	Min-Max	°C	-20-43°C (out)	-20-43°C (out)	-20-43°C (out)	-20-43°C (out)
Grijanje						
Kapacitet	Nominal (Min-Max)	Btu/h	10920 (2730-14330)	14330 (3410-17740)	20470 (4770-23540)	27300 (8190-29000)
Kapacitet	Nominal (Min-Max)	kW	3.2 (0.8-4.2)	4.2 (1.0-5.2)	6.0 (1.4-6.9)	8.0 (2.4-8.5)
Energetska efikasnost	SCOP/COP (Mild)		4.6/4.00	4.6/3.81	4.6/4.00	4.0/3.71
	SCOP (Warm/Cold)		5.1/-	5.1/-	5.1/3.4	5.4/-
Energetski razred	Mild/Warm/Cold		A++/A+++/-	A++/A+++/-	A++/A+++/A	A+/A+++/-
Pdesign (-10°C)		kW	2.4	2.8	4.6	5.6
Snaga električnog priključka	Nominal (Min-Max)	kW	0.8 (0.30-1.50)	1.1 (0.5-1.6)	1.5 (0.5-2.35)	2.16 (0.7-2.9)
Godišnja potrošnja energije		kWh/a	731	854	1400	1959
Temperaturni raspon rada		°C	-20-24°C (out)	-20-24°C (out)	-20-24°C (out)	-20-24°C (out)
Napajanje	Ph/V/Hz		1/220-240/50	1/220-240/50	1/220-240/50	1/230/50
	Polozaj		Vanjska jedinica	Vanjska jedinica	Vanjska jedinica	Vanjska jedinica
Unutarnja jedinica						
Neto dimenzije	Š / D / V	mm	856/197/300	856/197/300	999/225/323	1115/235/343
Dimenzije sa ambalažom	Š / D / V	mm	952/283/389	952/283/389	1100/314/420	1202/319/432
Neto/bruto težina		kg	9.5/12	9.5/12	12/15	15.2/18.2
Protok zraka	Max	m³/h	600	650	900	1100
Razina buke - zvučna snaga	Hlađenje (Hi/Mid/Lo/So)	dB(A)	38/32/25/16	39/33/26/17	45/41/37/28	47/43/37/33
	Grijanje (Hi/Mid/Lo/So)	dB(A)	38/32/25/19	39/33/26/20	45/41/37/28	47/43/37/33
Odvlaživanje		10-3m³/h	1.2	1.6	2	2.8
Vanjska jedinica						
Neto dimenzije	Š / D / V	mm	800/275/553	800/275/553	820/305/643	890/353/697
Dimenzije sa ambalažom	Š / D / V	mm	902/375/607	902/375/607	940/390/697	1046/460/780
Neto/bruto težina		kg	27.6/30.4	30/32.9	35.7/38.5	45/50
Protok zraka	Max	m³/h	1900	2000	3000	3000
Razina buke - zvučna snaga	Hi	dB(A)	47	48	50	57
Radna struja	Max	A	6.8	7.2	10.7	13
Vrsta radne tvari	R32		R32	R32	R32	R32
Količina radne tvari	R32	g	630	780	1100	1300
Promjeri cijevi	Tekućinski	mm	6.35	6.35	6.35	9.52
	Plinski	mm	9.52	9.52	12.7	15.88
	Max. dozvoljena duljina	m	20/10	20/10	25/15	50/30
	Max. duljina cjevovoda bez nadopune	m	7	7	7	7
	Nadopuna po dodatnom metru	g/m	20	20	20	45
Razmak između nogica - informacije se nalaze u zadnjem dijelu kataloga.						



■ PREDNOSTI



UVC sterilizacija

Emitira UV zrake te na taj način sterilizira zrak koji prolazi kroz klima uređaj s učinkovitošću od 99,9%.



56°C sterilizacija

Ubija bakterije i viruse zagrijavanjem isparivača na 56°C u trajanju od 30 minuta.



Coanda Plus protok zraka

Osigurava dalji, brži i jači ispuh zraka iz klima uređaja, kako bi zrak bio jednakomjerno raspodijeljen po cijeloj prostoriji.

Popis svih funkcija za navedeni model nalazi se na stranicama 34. – 39.



Super grijanje



Super tihi rad



Auto restart



On-Off card



Wi-Fi kontrola (hOn)



Jednostavna instalacija

Pearl

Model	Unutarnja		AS25PBAHRA	AS35PBAHRA	AS50PDAHRA	AS68PDAHRA
	Vanjska		1U25YEGFRA-H1	1U35YEGFRA-H1	1U50MEGFRA-H	1U68WEGFRA
Hlađenje						
Kapacitet	Nominal (Min-Max)	Btu/h	8870(2730-10238)	11940(2730-12286)	17060(4430-19790)	23200(7500-29000)
	Nominal (Min-Max)	kW	2.6(0.8-3.0)	3.5(0.8-3.6)	5.0(1.3-5.8)	6.80(2.20-8.50)
Energetska efikasnost	SEER/EER		6.1/3.23	6.1/2.9	6.1/3.23	6.80/3.23
Energetski razred			A++	A++	A++	A++
Pdesign kapacitet		kW	2.6	3.5	5.0	6.80
Snaga električnog priključka	Nominal (Min-Max)	kW	0.8(0.3-1.2)	1.21(0.3-1.6)	1.55(0.4-2.0)	2.10(0.70-2.90)
Godišnja potrošnja energije		kWh/a	149	201	287	350
Temperaturni raspon rada	Min-Max	°C	-10-43°C (out)	-10-43°C (out)	-10-43°C (out)	-10-43°C (out)
Grijanje						
Kapacitet	Nominal (Min-Max)	Btu/h	9555(2730-10920)	11940(2730-14330)	17240(4770-20470)	23200(8180-32410)
Kapacitet	Nominal (Min-Max)	kW	2.8(0.8-3.2)	3.5(0.8-4.2)	5.2(1.4-6.0)	6.8(2.40-9.50)
Energetska efikasnost	SCOP/COP (Mild)		4.0/3.71	4.0/3.71	4.0/3.71	4.0/3.71
	SCOP (Warm/Cold)		5.1/-	5.1/-	5.1/-	5.10/-
Energetski razred	Mild/Warm/Cold		A+/A+++/-	A+/A+++/-	A+/A+++/-	A+/A+++/-
Pdesign (-10°C)		kW	2.4	2.8	4.6	5.60
Snaga električnog priključka	Nominal (Min-Max)	kW	0.75(0.3-1.4)	0.94(0.3-1.6)	1.4(0.52-2.5)	1.8(0.60-2.90)
Godišnja potrošnja energije		kWh/a	840	980	1610	1960
Temperaturni raspon rada		°C	-20-24°C (out)	-20-24°C (out)	-20-24°C (out)	-15-24°C (out)
Napajanje	Ph/V/Hz		1/220-240/50	1/220-240/50	1/220-240/50	1/220-240/50
	Pozicija		Vanjska jedinica	Vanjska jedinica	Vanjska jedinica	Vanjska jedinica
Unutarnja jedinica						
Neto dimenzije	Š / D / V	mm	805/200/290	805/200/290	975/220/320	975/220/320
Dimenzije sa ambalažom	Š / D / V	mm	874/270/363	874/270/363	1050/301/397	1050/301/397
Neto/bruto težina		kg	8.3/10.5	8.3/10.5	11.6/14.4	11.6/14.4
Protok zraka	Max	m ³ /h	550	600	900	1100
Razina buke - zvučna snaga	Hlađenje (Hi/Mid/Lo/So)	dB(A)	37/32/28/18	37/33/29/19	44/40/35/28	47/45/37/29
	Grijanje (Hi/Mid/Lo/So)	dB(A)	37/32/28/18	37/33/29/19	44/40/35/28	47/45/37/29
Odvlaživanje		10-3m ³ /h	1	1.3	2	2.8
Vanjska jedinica						
Neto dimenzije	Š / D / V	mm	700/245/544	700/245/544	800/275/553	890/340/705
Dimenzije sa ambalažom	Š / D / V	mm	819/320/585	819/320/589	902/375/607	1046/460/780
Neto/bruto težina		kg	22.8/25.3	23.6/26.1	32.7/36.5	44/48
Protok zraka	Max	m ³ /h	2100	2100	2500	2600
Razina buke - zvučna snaga	Hi	dB(A)	49	50	53	53
Radna struja	Max	A	6.2	7.1	11.3	13
Vrsta radne tvari	R410a/R32		R32	R32	R32	R32
Količina radne tvari	R410a/R32	g	520	530	900	1100
Promjeri cijevi	Tekućinski	mm	6.35	6.35	6.35	6.35
	Plinski	mm	9.52	9.52	12.7	12.7
	Max. dozvoljena duljina	m	20/10	20/10	25/15	25/15
	Max. duljina cjevovoda bez nadopune	m	5	5	7	7
	Nadopuna po dodatnom metru	g/m	20	20	20	20
Razmak između nogica - informacije se nalaze u zadnjem dijelu kataloga.						

Tundra Plus

Haier klima uređaji



Adapter za žičani kontroler



Žičani kontroler (opcija)



■ PREDNOSTI



Frost Clean

Smrzava isparivač pomoću vlage iz zraka, te na taj način veže čestice nečistoće i otapanjem ih uklanja kroz odvod kondenzata, dok na ispuhu osigurava čisti zrak.



PID control

Maksimizira radnu frekvenciju kako bi u što kraćem roku postigao željenu temperaturu prostora, a nakon toga u realnom vremenu stalno prilagođava frekvenciju uređaja kako bi održavao željenu temperaturu u prostoriji.



Super tihi rad

Optimiziran rad ventilatora i motora pruža korisniku potpuni mir i tišinu.



Frost Clean



Inteligentan zrak



Ugodan san



Super tihi rad



Wi-Fi kontrola (hOn)



-15°C grijanje



On-Off card



Produžena montažna nožica

Popis svih funkcija za navedeni model nalazi se na stranicama 34. – 39.

Tundra Plus

Model	Unutarnja		AS25TAEHRA-THC	AS35TADHRA-THC	AS50TDDHRA-THC	AS68TDRHRA-THC
	Vanjska		1U25YEFFRA-1	1U35MEEFRA-1	1U50MEMFRA-C	1U68WEGFRA-C
Hlađenje						
Kapacitet	Nominal (Min-Max)	Btu/h	8870(2730-10238)	12280(3410-13650)	17060(4430-19790)	23200(7500-29000)
	Nominal (Min-Max)	kW	2.6(0.8-3.0)	3.6(1.0-4.0)	5.0(1.3-5.8)	6.8(2.2-8.5)
Energetska efikasnost	SEER/EER		6.1/3.23	6.4/3.23	6.1/3.41	6.8/3.23
Energetski razred			A++	A++	A++	A++
Pdesign kapacitet		kW	2.6	3.6	5.0	6.8
Snaga električnog priključka	Nominal (Min-Max)	kW	0.8(0.3-1.2)	1.1(0.3-1.50)	1.47(0.40-2.00)	2.1(0.70-2.90)
Godišnja potrošnja energije		kWh/a	149	197	287	350
Temperaturni raspon rada	Min-Max	°C	-10-43°C (out)	-10-43°C (out)	-10-43°C (out)	-15-43°C (out)
Grijanje						
Kapacitet	Nominal (Min-Max)	Btu/h	9555(2730-10920)	12620(3750-15690)	17740(4770-20470)	23200(8180-32410)
Kapacitet	Nominal (Min-Max)	kW	2.8(0.8-3.2)	3.7(1.1-4.6)	5.2(1.4-6.0)	6.8(2.40-9.50)
Energetska efikasnost	SCOP/COP (Mild)		4.0/3.71	4.1/3.71	4.0/3.71	4.0/3.71
	SCOP (Warm/Cold)		5.1//	5.1/-	5.1/-	5.1/-
Energetski razred	Mild/Warm/Cold		A+/A+++//	A+/A+++/-	A+/A+++/-	A+/A+++/-
Pdesign (-10°C)		kW	2.4	3.2	4.6	5.6
Snaga električnog priključka	Nominal (Min-Max)	kW	0.75(0.3-1.4)	0.99(0.40-1.50)	1.40(0.52-2.5)	1.83(0.60-2.90)
Godišnja potrošnja energije		kWh/a	840	1092	1610	1960
Temperaturni raspon rada		°C	-15-24°C (out)	-15-24°C (out)	-15-24°C (out)	-15-24°C (out)
Napajanje	Ph/V/Hz		1/220-240/50	1/230/50	1/230/50	1/220-240/50
	Pozicija		Vanjska jedinica	Vanjska jedinica	Vanjska jedinica	Vanjska jedinica
Unutarnja jedinica						
Neto dimenzije	Š / D / V	mm	820/195/280	820/195/280	1008/225/318	1008/225/318
Dimenzije sa ambalažom	Š / D / V	mm	883/269/342	883/269/342	1085/329/403	1085/329/403
Neto/bruto težina		kg	8.2/10.5	8.4/10.5	11.6/14.4	11.6/14.4
Protok zraka	Max	m ³ /h	500	550	900	1100
Razina buke - zvučna snaga	Hlađenje (Hi/Mid/Lo/So)	dB(A)	37/33/29/19	38/33/29/21	44/40/35/28	48/44/38/33
	Grijanje (Hi/Mid/Lo/So)	dB(A)	37/33/29/19	38/33/29/21	44/40/35/28	48/44/38/33
Odvlaživanje		10-3m ³ /h	1	1.6	2.0	2.8
Vanjska jedinica						
Neto dimenzije	Š / D / V	mm	700/245/544	800/275/553	800/275/553	890/340/705
Dimenzije sa ambalažom	Š / D / V	mm	819/320/585	902/375/607	902/375/607	1046/460/780
Neto/bruto težina		kg	22.8/25.3	27/30.3	32.7/36.5	44/48
Protok zraka	Max	m ³ /h	2100	2000	2500	2600
Razina buke - zvučna snaga	Hi	dB(A)	49	48	53	57
Radna struja	Max	A	6.2	6.7	11.3	13
Vrsta radne tvari			R32	R32	R32	R32
Količina radne tvari		g	510	620	900	1100
Promjeri cijevi	Tekućinski	mm	6.35	6.35	6.35	6.35
	Plinski	mm	9.52	9.52	12.7	12.7
	Max. dozvoljena duljina	m	20/10	20/10	25/15	25/15
	Max. duljina cjevovoda bez nadopune	m	5	5	7	7
	Nadopuna po dodatnom metru	g/m	20	20	20	20
Razmak između nogica - informacije se nalaze u zadnjem dijelu kataloga.						



■ PREDNOSTI



Frost Clean

Smrzava isparivač pomoću vlage iz zraka, te na taj način veže čestice nečistoće i otapanjem ih uklanja kroz odvod kondenzata, dok na ispuhu osigurava čisti zrak.



Super tihi rad

Optimiziran rad ventilatora i motora pruža korisniku potpuni mir i tišinu.



Wi-Fi kontrola

Preuzimanjem Haier hOn aplikacije na pametni uređaj (Apple ili Android), omogućuje se upravljanje i kontrola klima uređaja s bilo koje lokacije i bilo kada.



Topli start



Frost Clean



Inteligentan zrak



Ugodan san



Funkcija isušivanja



-15°C grijanje



Turbo hlađenje



Produžena montažna nožica

Popis svih funkcija za navedeni model nalazi se na stranicama 34. – 39.

Tide Plus

Model	Unutarnja		AS25THMHRA-C	AS35TAMHRA-C	AS50TDMHRA-C	AS68TDRHRA-C
	Vanjska		1U25YEFFRA-C	1U35YEFFRA-C	1U50MEMFRA-C	1U68WEGFRA-C
Hlađenje						
Kapacitet	Nominal (Min-Max)	Btu/h	8870(2730-10238)	10920(2730-12286)	17060(4430-19790)	23200(7500-29000)
	Nominal (Min-Max)	kW	2.6(0.8-3.0)	3.2(0.8-3.6)	5.0(1.3-5.8)	6.8(2.20-8.50)
Energetska efikasnost	SEER/EER		6.1/3.23	6.1/3.01	6.1/3.41	6.8/3.23
Energetski razred			A++	A++	A++	A++
Pdesign kapacitet		kW	2.6	3.2	5.0	6.8
Snaga električnog priključka	Nominal (Min-Max)	kW	0.8(0.3-1.2)	1.06(0.3-1.6)	1.47(0.40-2.0)	2.10(0.70-2.90)
Godišnja potrošnja energije		kWh/a	149	184	287	350
Temperaturni raspon rada	Min-Max	°C	-10-43°C (out)	-10-43°C (out)	-10-43°C (out)	-15-43°C (out)
Grijanje						
Kapacitet	Nominal (Min-Max)	Btu/h	9555(2730-10920)	11603(2730-14330)	17740(4770-20470)	23200(8180-32410)
Kapacitet	Nominal (Min-Max)	kW	2.8(0.8-3.2)	3.4(0.8-4.2)	5.2(1.4-6.0)	6.8(2.40-9.50)
Energetska efikasnost	SCOP/COP (Mild)		4/3.71	4/3.40	4.0/3.71	4.0/3.71
	SCOP (Warm/Cold)		5.1/-	5.1/-	5.10/-	5.10/-
Energetski razred	Mild/Warm/Cold		A+/A+++/-	A+/A+++/-	A+/A+++/-	A+/A+++/-
Pdesign (-10°C)		kW	2.4	2.8	4.60	5.60
Snaga električnog priključka	Nominal (Min-Max)	kW	0.75(0.3-1.4)	1.0(0.3-1.6)	1.4(0.52-2.50)	1.8(0.60-2.90)
Godišnja potrošnja energije		kWh/a	840	980	1610	1960
Temperaturni raspon rada		°C	-15-24°C (out)	-15-24°C (out)	-15-24°C (out)	-15-24°C (out)
Napajanje	Ph/V/Hz		1/220-240/50	1/220-240/50	1/220-240/50	1/220-240/50
	Polozaj		Vanjska jedinica	Vanjska jedinica	Vanjska jedinica	Vanjska jedinica
Unutarnja jedinica						
Neto dimenzije	Š / D / V	mm	820/195/280	820/195/280	1008/225/318	1008/225/318
Dimenzije sa ambalažom	Š / D / V	mm	883/342/269	883/342/269	1085/329/403	1085/329/403
Neto/bruto težina		kg	8.2/10.5	8.2/10.5	11.6/14.4	11.6/14.4
Protok zraka	Max	m³/h	500	550	900	1100
Razina buke - zvučna snaga	Hlađenje (Hi/Mid/Lo/So)	dB(A)	37/33/29/19	38/34/29/20	44/40/35/28	48/44/38/33
	Grijanje (Hi/Mid/Lo/So)	dB(A)	37/33/29/19	38/34/29/20	44/40/35/28	48/44/38/33
Odvlaživanje		10-3m³/h	1	1.4	2.0	2.8
Vanjska jedinica						
Neto dimenzije	Š / D / V	mm	700/245/544	700/245/544	800/275/553	890/340/705
Dimenzije sa ambalažom	Š / D / V	mm	819/320/585	819/320/585	902/375/607	1046/460/780
Neto/bruto težina		kg	22.8/25.3	23.5/26	32.7/36.5	44/48
Protok zraka	Max	m³/h	2100	2100	2500	2600
Razina buke - zvučna snaga	Hi	dB(A)	49	50	53	57
Radna struja	Max	A	6.2	7.1	11.3	13
Vrsta radne tvari	R32		R32	R32	R32	R32
Količina radne tvari	R32	g	510	530	900	1100
Promjeri cijevi	Tekućinski	mm	6.35	6.35	6.35	6.35
	Plinski	mm	9.52	9.52	12.7	12.7
	Max. dozvoljena duljina	m	20/10	20/10	25/15	25/15
	Max. duljina cjevovoda bez nadopune	m	5	5	7	7
	Nadopuna po dodatnom metru	g/m	20	20	20	20
Razmak između nogica - informacije se nalaze u zadnjem dijelu kataloga.						



■ PREDNOSTI

Dizajn	Pametne značajke	Ugodno korisničko iskustvo	Performanse
Inovativan i kompaktan dizajn.	Hladi cijelu prostoriju uz pomoć funkcije automatskog usmjeravanja strujanja zraka.	Dvosmjerni odvod kondenzata. Dostupne opcije: automatski/ručno.	Jedinica se može koristiti kao klima uređaj / ventilator/odvlaživač zraka u svim vrstama prostora.
LED display.	Otvor za izlaz zraka automatski se otvara i zatvara pritiskom tipke on/off.	Kotačići za jednostavno premještanje uređaja.	Snažan kapacitet hlađenja. Jak ispuh zraka (350m ³ /h *model AM09AA1GAA).
Ergonomski dizajn upravljačke ploče.	Prikaz greške koda u slučaju kvara uređaja radi lakšeg i bržeg održavanje (Samo dijagnoza).	Držač za namatanje kabela za napajanje osigurava jednostavnu pohranu uređaja.	Tihi rad 48 dB (A) pri niskoj brzini rada ventilatora.
	Postavljanje vremena nakon kojeg će se uređaj uključiti/isključiti (24h Timer).	Kadica za skupljanje kondenzata.	

Mobilni klima uređaj



MOBILNI KLIMA UREĐAJ		AM09AA1GAA	AM12AA1GAA
Kapacitet (hlađenje)	kW	2.6	3.5
Kapacitet (grijanje)	kW	2.9	3.3
Energetska efikasnost/razred	EER	A(2.61)	A(2.61)
Energetska efikasnost/razred	COP	2.8	A(2.75)
Snaga električkog priključka	kW	1.01	1.01
Radna struja (max.)	A	4.8	5.9
Napajanje	Ph/V/HZ	1/220-240/50	1/220-240/50
Neto dimenzije (ŠxDxV)	mm	443x340x815	443x340x815
Dimenzije s ambalažom (ŠxDxV)	mm	480x435x880	480x435x880
Neto/Bruto težina	kg	25/30	28/33
Protok zraka (max.)	m ³ /h	350	350
Vrsta radne tvari		R290	R290
Količina radne tvari	g	235	245
Odvlaživanje	L/h	0,9	1,2
Razina buke/zvučna snaga (Hi/Mid/Lo)	dB(A)	56/54/52	56/54/52
Duljina kabela	m	1	1
Duljina cijevi za odvod	m	1	1
Promjer cijevi za odvod	cm	12	12

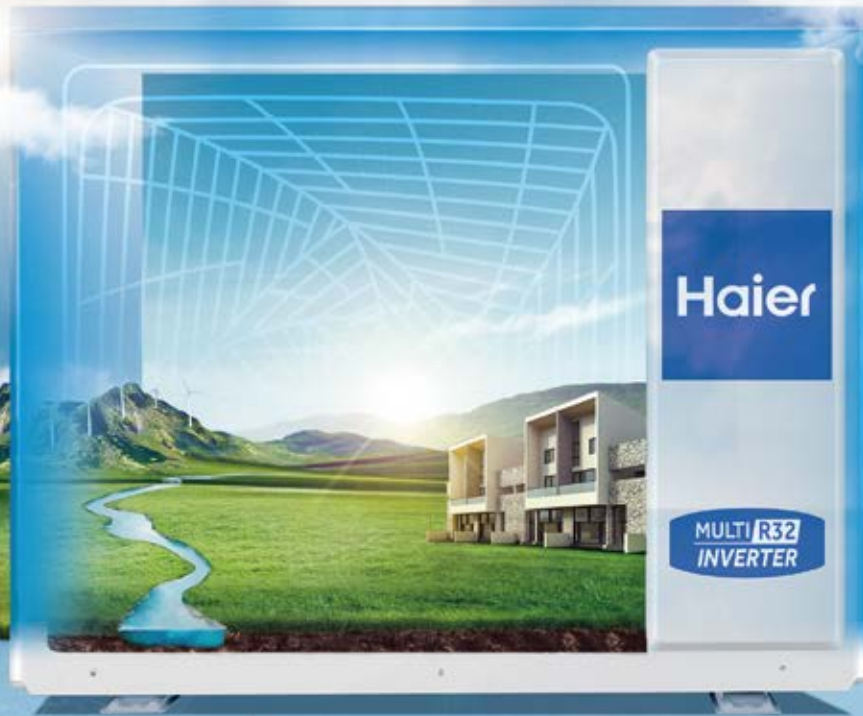

A+++



R32 SUPER MATCH MULTI SUSTAVI

Multi split klima uređaji Haier pravi su odabir za one koji žele klimatizirati više prostorija u domu ili u objektima komercijalne namjene.













Predstavljaju idealno estetsko i konstrukcijsko rješenje za grijanje i hlađenje više prostorija: za veće stambene ili poslovne prostore, apartmane, hotele, restorane itd.

Opcije unutarnjih jedinica su zidna, kazetna i podna, različitih raspona snage, ovisno o preferencijama i potrebama korisnika.

- unutarnje jedinice mogu biti različitih tipova ugradnje i međusobno različitih kapaciteta
- individualno upravljanje ili grupno















PREGLED MODELA

SERIJA	2,5 kW	3,5 kW
Jade Super Match	 <p>AS25S2SJ1FA-3</p>	 <p>AS35S2SJ1FA-3</p>
Expert	 <p>AS25XCAHRA</p>	 <p>AS35XCAHRA</p>
Flexis Plus	 <p>AS25S2SF1FA-WH S25S2SF1FA-S AS25S2SF1FA-BH</p>	 <p>AS35S2SF1FA-WH AS35S2SF1FA-S AS35S2SF1FA-BH</p>
Pearl	 <p>AS25PBAHRA</p>	 <p>AS35PBAHRA</p>
Tundra	 <p>AS25TAEHRA-THC</p>	 <p>AS35TADHRA-THC</p>
Tide	 <p>AS25THMHRA-C</p>	 <p>AS35TAMHRA-C</p>



Multi split R32















5 kW	7,1 kW		
			
 <p data-bbox="272 864 411 887">AS50XCAHRA</p>			
 <p data-bbox="252 1223 432 1272">AS50S2SF1FA-WH AS50S2SF1FA-BH</p>	 <p data-bbox="707 1223 887 1272">AS71S2SF1FA-WH AS71S2SF1FA-BH</p>		
 <p data-bbox="272 1529 411 1552">AS50PDAHRA</p>	 <p data-bbox="735 1529 874 1552">AS68PDAHRA</p>		
 <p data-bbox="248 1794 435 1816">AS50TDDHRA-THC</p>	 <p data-bbox="707 1794 893 1816">AS68TDRHRA-THC</p>		
 <p data-bbox="260 2063 427 2085">AS50TDMHRA-C</p>	 <p data-bbox="722 2063 890 2085">AS68TDRHRA-C</p>		

PREGLJED MODELA

SERIJA	2,5 kW	3,5 kW	5,0 kW	5,5 kW	7,0 kW	7,5 kW
Kompaktni kazetni model - mini (panel: PB620 KB(H))	 AB25S2SC2FA	 AB35S2SC2FA				
Kompaktni kazetni model - (panel: PB620 KB(H))	 AB25S2SG2FA (H)	 AB35S2SG2FA (H)				
360° kazetni model PB 950 KB(H)	●	●				
Slim kanalni model (niski ESP)	 AD25S2SS1FA(H) Panel: P1B-890IA/D (opcija)	 AD35S2SS1FA(H) Panel: P1B-890IA/D (opcija)				
Slim kanalni model (srednji ESP)	●	 AD35S2SM3FA (H)				
Podnostropni model	●	 AC35S2SG1FA (H)				
Podni inverter model	 AF25S2SD1FA(H)	 AF35S2SD1FA(H)				
VANJSKE JEDINICE	 2U50S2SM1FA-3	 3U55S2SR5FA	 3U70S2SR5FA	 4U75S2SR5FA		



Multi split R32

4,2 kW		5 kW		7,1 kW			
•		 AB50S2SC2FA		•			
•		 AB50S2SG2FA (H)		 AB71S2SG2FA (H)			
•		•		 AB71S2SG1FA			
•		 AD50S2SS1FA (H) Panel: P1B-1210IA/D (opcija)		 AD71S2SS1FA (H) Panel: P1B-1210IA/D (opcija)			
•		 AD50S2SM3FA (H)		 AD71S2SM3FA (H)			
•		 AC50S2SG1FA (H)		 AC71S2SG1FA (H)			
 AF42S2SD1FA(H)		•		•			
8,5 kW		9,0 kW		10,5 kW		12,5 kW	
 4U85S2SR5FA		 5U90S2SS5FA		 5U105S2SS5FA		 5U125S2SN1FA	

Multi inverter



Model		2U50S2SM1FA	3U55S2SR5FA	3U70S2SR5FA
Maksimalan broj unutarnjih jedinica		2	3	3
Kapacitet - hlađenje	kW	5.0	5.0(2.1-6.6)	7.0(2.4-7.6)
Kapacitet - grijanje	kW	5.7	6.4(1.7-7.2)	7.6(2.9-8.5)
SEER / SCOP		6.5/4.0	8.5/4.6	8.5/4.6
Energetska klasa (grijanje / hlađenje)		A++/A+	A+++/A++	A+++/A++
Napajanje	PhV/Hz	1/230/50		1/220-240/50/60
Protok zraka (H/M/L)	m³/h	2200	≈3000	≈3000
Razina buke - zvučna snaga H/M/L	db(A)	62	64	66
Razina zvučnog tlaka H/M/L	db(A)	56	51	53
Vanjske dimenzije W/D/H	mm	800/275/553	890/340/700	890/340/700
Neto / Bruto težina	kg	34/37	50/59	54/63
Radna tvar		R32	R32	R32
Promjer cijevi tekućinski	mm	2×6.35	3×6.35	3×6.35
Promjer cijevi plinski	mm	2×9.52	3×9.52	3×9.52
Maksimalna duljina cjevovoda	m	30	50	60
Maksimalna duljina cjevovoda bez nadopune	m	20	30	30
Maksimalna visinska razlika	m	15	15	15
Temperaturni raspon rada - hlađenje	°C	-10-46	-10-46	-10-46
Temperaturni raspon rada - grijanje	°C	-15-24	-15-24	-15-24
Razmak između nogica	mm	510	630	630

KOMBINACIJE SPAJANJA UNUTARNJIH I VANJSKIH JEDINICA

Multi R32					2 unutarnje jedinice							3 unutarnje jedinice												
Broj unutarnjih jedinica	2	3	4	5	9	9	9	9	12	12	12	12	18	18	24	9	9	9	9	9	9	9		
					9	12	18	24	12	18	24	18	24	24	24	9	9	9	9	9	12	12	12	
					-	-	-	-	-	-	-	-	-	-	-	9	12	18	24	12	18	24	24	
					-	-	-	-	-	-	-	-	-	-	-	-	-	-	-	-	-	-	-	
					-	-	-	-	-	-	-	-	-	-	-	-	-	-	-	-	-	-	-	
Vanjska jedinica	2U50S2SM1FA	*	*			*																		
	3U55S2SR5FA	*	*	*		*										*								
	3U70S2SR5FA	*	*	*		*	*									*	*				*			
	4U75S2SR5FA	*	*	*	*	*	*	*	*	*	*	*	*	*	*	*	*	*	*	*	*	*	*	*
	4U85S2SR5FA	*	*	*		*	*	*	*	*	*	*	*	*	*	*	*	*	*	*	*	*	*	*
	5U90S2SS5FA	*	*	*	*	*	*	*	*	*	*	*	*	*	*	*	*	*	*	*	*	*	*	*
	5U105S2SS5FA	*	*	*	*	*	*	*	*	*	*	*	*	*	*	*	*	*	*	*	*	*	*	*
5U125S2SN1FA	*	*	*	*	*	*	*	*	*	*	*	*	*	*	*	*	*	*	*	*	*	*	*	

*Obavezno prije kupnje Multi invertera opcije (Super Match) potrebno je provjeriti tehničke specifikacije i mogućnosti instalacije s ovlaštenim Haier serviserima. Za detaljne informacije posjetite www.haier-klima.com.



Model		4U7S2SR5FA	4U85S2SR5FA	5U90S2SS5FA	5U105S2SS5FA
Maksimalan broj unutarnjih jedinica		4	4	5	5
Kapacitet - hlađenje	kW	7.6(2.4-8.7)	8.5(3.2-9.5)	9.0(3.2-11.0)	10(3.2-11.0)
Kapacitet - grijanje	kW	8.6(3.1-10.0)	9.3(4.4-10.5)	10.4(4.4- 11.5)	10.5(4.4- 11.5)
SEER / SCOP		7.0/4.2	7.0/4.2	7.0/4.2	7.0/4.2
Energetska klasa (grijanje / hlađenje)		A++/A+	A++/A+	A++/A+	A++/A+
Napajanje	Ph/V/Hz	1/220-240/50/60	1/220-240/50/60	1/220-240/50/60	1/220-240/50/60
Protok zraka (H/M/L)	m ³ /h	≈4000	≈4000	4200	4200
Razina buke - zvučna snaga H/M/L	db(A)	68	68	70	70
Razina zvučnog tlaka H/M/L	db(A)	55	55	55	55
Vanjske dimenzije W/D/H	mm	890/340/700	890/340/700	920/372/760	920/372/760
Neto / Bruto težina	kg	61/70	61/70	66/77	66/70
Radna tvar		R32	R32	R32	R32
Promjer cijevi tekućinski	mm	4×6.35	4×6.35	5×6.35	5×6.35
Promjer cijevi plinski	mm	3×9.52+1×12.7	3×9.52+1×12.7	3×9.52+2×12.7	3×9.52+2×12.7
Maksimalna duljina cjevovoda	m	70	70	80	80
Maksimalna duljina cjevovoda bez nadopune	m	40	40	40	40
Maksimalna visinska razlika	m	15	15	15	15
Temperaturni raspon rada - hlađenje	°C	-10-46	-10-46	-10-46	-10-46
Temperaturni raspon rada - grijanje	°C	-15-24	-15-24	-15-24	-15-24
Razmak između nogica	mm	630	630	/	660

						4 unutarnje jedinice										5 unutarnjih jedinica					
12	12	12	12	12	18	9	9	9	9	9	9	9	9	9	9	12	9	9	9	9	9
12	12	12	18	18	18	9	9	9	9	9	9	12	12	12	12	12	9	9	9	9	9
12	18	24	18	24	18	9	9	9	9	12	12	12	12	12	12	9	9	9	9	9	
-	-	-	-	-	-	9	12	18	24	12	18	12	18	24	12	9	9	9	12	12	
-	-	-	-	-	-	-	-	-	-	-	-	-	-	-	-	9	12	18	12	18	
*	*					*	*			*											
*	*	*	*			*	*	*		*	*	*			*						
*	*	*	*	*	*	*	*	*	*	*	*	*	*	*	*	*	*	*	*	*	
*	*	*	*	*	*	*	*	*	*	*	*	*	*	*	*	*	*	*	*	*	
*	*	*	*	*	*	*	*	*	*	*	*	*	*	*	*	*	*	*	*	*	

Haier

KOMERCIJALNA SERIJA KLIMA UREĐAJA







KOMPAKTNI KAZETNI MODEL

Elegantan izgled unutarnjih jedinica

Dimenzije unutarnjih jedinica 620 x 620 mm prilagođene su standardnim dimenzijama dekorativnih stropnih panel - ploča. Dizajn unutarnjih jedinica poboljšán je sa spiralnim rešetkama.

UVC sterilizacija

Ugrađeno UV LED svjetlo sterilizira zrak koji cirkulira klima uređajem. Učinkovito eliminira viruse i bakterije pri čemu isporučuje zdrav zrak u prostoriju.



Kompaktni kazetni model



Kompaktni dizajn
620x620 mm



Individualna
kontrola klapni



Wi-Fi



UVC sterilizacija



Antibakterijski
filter



ABS materijal
panela



Jednostavna
instalacija i
održavanje



KAZETNI MODEL	Unutarnja	AB35S2SC2FA (H)	AB50S2SC2FA (H)
	Vanjska	1U35S2SM1FA-2	1U50S2SJ2FA-2
Kapacitet - hlađenja	kW	3.5 (0.9-4.5)	5.0 (1.8-5.8)
Kapacitet - grijanje	kW	4.0 (1-4.8)	5.5 (2-6.5)
SEER/SCOP		6.1/3.8	6.1/4.0
Energetska klasa		A++/A	A++/A+
Unutarnja jedinica			
Napajanje	Ph/V/Hz	1/220~240/50/60	1/220~240/50/60
Protok zraka H/M/L	m³/h	620/520/450	700/620/500
Razina buke - zvučna snaga H/M/L	dB(A)	52	55
Razina zvučnog tlaka H/M/L	dB(A)	36/33/30	42/37/35/32
Vanjske dimenzije Š/D/V	mm	570/570/260	570/570/260
Dimenzije sa ambalažom Š/D/V	mm	718/680/380	718/680/380
Neto / Bruto težina	kg	18.5/22	19/22
Daljinski	Opcija - bežični	YR-HQS01	YR-HQS01
	Opcija - žičani	YR-E17A	YR-E17A
Model panela		PB-620 KB (H) (standard)	PB-620 KB (H) (standard)
Vanjske dimenzije Š/D/V	mm	620/620/60	620/620/60
Dimenzije sa ambalažom Š/D/V	mm	660/660/115	660/660/115
Neto / Bruto težina	kg	2.8/4.5	2.8/4.5
Vanjska jedinica			
Napajanje	Ph/V/Hz	1/220-240/50	1/230/50
Protok zraka H/M/L	m³/h	2000	3000
Razina buke - zvučna snaga H/M/L	dB(A)	61	63
Razina zvučnog tlaka H/M/L	dB(A)	48	50
Vanjske dimenzije Š/D/V	mm	800/275/553	820/305/643
Dimenzije sa ambalažom Š/D/V	mm	908/405/625	940/390/697
Neto / bruto težina	kg	30/32.9	35.7/38.5
Radna tvar		R32	R32
Promjer cijevi tekućinski	mm	6.35	6.35
Promjer cijevi plinski	mm	9.52	12.7
Maksimalna duljina cjevovoda	m	20	25
Maksimalna visinska razlika	m	10	15
Temperaturni raspon rada - hlađenje	°C	-20~43	-20~43
Temperaturni raspon rada - grijanje	°C	-20~24	-20~24



360° KAZETNI MODEL

360° ispuh zraka uz moderan dizajn

Haier kazetne unutarnje jedinice ugrađuju se u spuštene stropove te se prilagođavaju svakom prostoru. Konstrukcija klapni dizajnirana je na način da klimatizirani zrak dospjeđe u svaki dio prostorije.

UVC sterilizacija

Ugrađeno UV LED svjetlo sterilizira zrak koji cirkulira klima uređajem. Učinkovito eliminira viruse i bakterije pri čemu isporučuje zdrav zrak u prostoriju.



360° kazetni model



360° ispuh zraka



Individualna kontrola klapni



Wi-Fi



UVC sterilizacija



Antibakterijski filter



Ugrađena pumpa za odvod kondenzata
max. 1000 mm



Jednostavna instalacija i održavanje



Skriven LCD display



KAZETNI MODEL	Unutarnja	AB71S2SG1FA (H)	ABH105H1ERG (H)	ABH125K1ERG (H)	ABH140K1ERG (H)	ABH160K1ERG (H)
	Vanjska	1U71S2SR2FA	1U105S2SS2FA	1U125S2SN2FB	1U140S2SN1FB	1UH160P1ERG
Kapacitet - hlađenja	kW	7.1 (2-7.3)	9.2 (2.5-10.0)	12.4 (3.0-13.0)	13.4 (3.5-14.0)	15.00 (4.50-16.00)
Kapacitet - grijanje	kW	8.0 (2.5-8)	10.10 (3.0-10.5)	12.8 (3.5-13.5)	15.0 (4.0-15.5)	16.00 (5.00-17.00)
SEER/SCOP		6.1/3.8	5.9/3.8	5.71/3.96	5.62/3.96	5.96/3.99
Energetska klasa		A++/A	A+/A	/	/	/
Unutarnja jedinica						
Napajanje	Ph/V/Hz	1/220~240/50/60	1/220~240/50/60	1/220~240/50/60	1/220~240/50/60	1/220~240/50/60
Protok zraka H/M/L	m³/h	1260/1070/820/680	1680/1530/1320/1190	1950/1600/1440/1200	1950/1600/1440/1200	2050/1600/1440
Razina buke - zvučna snaga H/M/L	dB(A)	55	62	64	64	65
Razina zvučnog tlaka H/M/L	dB(A)	42/40/38	45/42/38/34	47/44/38/34	47/44/38/34	48/44/38
Vanjske dimenzije Š/D/V	mm	840/840/204	840/840/246	840/840/288	840/840/288	840/840/288
Dimenzije sa ambalažom Š/D/V	mm	990/990/310	990/990/330	990/990/380	990/990/380	990/990/380
Neto / Bruto težina	kg	27/32	31/36	32/38	32/38	32/38
Daljinski	Opcija - bežični	YR-HQS01	YR-HQS01	YR-HQS01	YR-HQS01	YR-HQS01
	Opcija - žičani	YR-E17A	YR-E17A	YR-E17A	YR-E17A	YR-E17A
Model panela		PB-950 KB (H) (standard)	PB-950 KB (H) (standard)	PB-950 KB (H) (standard)	PB-950 KB (H) (standard)	PB-950 KB (H) (standard)
Vanjske dimenzije Š/D/V	mm	950/950/50	950/950/50	950/950/50	950/950/50	950/950/50
Dimenzije sa ambalažom Š/D/V	mm	1013/1025/123	1013/1025/123	1013/1025/123	1013/1025/123	1013/1025/123
Neto / Bruto težina	kg	6.5/9.5	6.5/9.5	6.5/9.5	6.5/9.5	6.5/9.5
Vanjska jedinica						
Napajanje	Ph/V/Hz	1/220~240/50/60	1/220~240/50/60	3/380-415/ 50/60	3/380-415/ 50/60	1/220-240/50/60
Protok zraka H/M/L	m³/h	3000	3500	4200	4200	7500
Razina buke - zvučna snaga H/M/L	dB(A)	67	66	72	72	73
Razina zvučnog tlaka H/M/L	dB(A)	54	53	58	58	57
Vanjske dimenzije Š/D/V	mm	890/340/700	920/372/765	950/370/965	950/370/965	1350/950/370
Dimenzije sa ambalažom Š/D/V	mm	1046/460/780	1036/478/820	1050/485/1130	1050/485/1130	1500/1090/480
Neto / bruto težina	kg	45/50	60/65	85/90	85/90	105/118
Radna tvar		R32	R32	R32	R32	R410A
Promjer cijevi tekućinski	mm	9.52	9.52	9.52	9.52	9.52
Promjer cijevi plinski	mm	15.88	15.88	15.88	15.88	15.88
Maksimalna duljina cjevovoda	m	50	50	50	70	75
Maksimalna visinska razlika	m	30	30	30	30	30
Temperaturni raspon rada - hlađenje	°C	-20~46	-20~46	-20~46	-20~46	-15~52
Temperaturni raspon rada - grijanje	°C	-20~24	-20~24	-20~24	-20~24	-20~24



SLIM KANALNI MODEL

Moderan dizajn

Haier slim kanalne jedinice dizajnirane su kako bi se prilagodile u prostore s ograničenim opcijama za klimatizaciju. Omogućen je 3D protok zraka kako bi se klimatizirao svaki dio prostorije.

Antibakterijski filter

Antibakterijski filter sadrži ione srebra i antibakterijske organske tvari na komponentama jedinice kroz koje prolazi zrak. Filter eliminira bakterije poput *Escherichia Coli* i *Staphylococcus aureus* s učinkovitošću do 99,99%.



Slim kanalni model



UVC sterilizacija



Antibakterijski filter



SLIM dizajn visina 185 mm



Wi-Fi



3D ispuh zraka



Super tihi rad (23 dB)



Ugrađena pumpa za odvod kondenzata



Dvostruki odvod kondenzata



Jednostavna instalacija i održavanje



SLIM KANALNI MODEL	Unutarnja	AD35S2SS1FA (H)	AD50S2SS1FA (H)	AD71S2SS1FA (H)
	Vanjska	1U35S2SM1FA	1U50S2SJ2FA	1U71S2SR2FA
Kapacitet - hlađenja	kW	3.5 (0.9-4.5)	5.0 (1.8-6)	7.1 (2-7.6)
Kapacitet - grijanje	kW	4.0 (1-4.8)	5.5 (2-6.2)	7.5 (3.0-8.30)
SEER/SCOP		6.1/3.8	6.1/4.0	6.1/3.8
Energetska klasa		A++/A	A++/A+	A++/A
Unutarnja jedinica				
Napajanje	Ph/V/Hz	1/220~240/50/60	1/220~240/50/60	1/220~240/50/60
Protok zraka H/M/L	m³/h	600/480/420	900/750/600	1000/850/750
Razina buke - zvučna snaga H/M/L	dB(A)	53	54	57
Razina zvučnog tlaka H/M/L	dB(A)	33/28/25	36/34/32	46/44/42
Model panela		P1B-890IA/D	P1B-1210IA/D	P1B-1210IA/D
Vanjske dimenzije Š/D/V	mm	850/420/185	1170/420/185	1170/420/185
Dimenzije sa ambalažom Š/D/V	mm	1045/530/260	1365/530/260	1365/530/260
Neto / Bruto težina	kg	16/21	22/28	25.2/28.4
Daljinski	Opcija - bežični	YR-E17A	YR-E17A	YR-E17A
	Opcija - žičani	YR-HQS01	YR-HQS01	YR-HQS01
Vanjska jedinica				
Napajanje	Ph/V/Hz	1/230/50	1/230/50	1/220~240/50/60
Protok zraka H/M/L	m³/h	2000	2500	3000
Razina buke - zvučna snaga H/M/L	dB(A)	61	63	67
Razina zvučnog tlaka H/M/L	dB(A)	48	51	54
Vanjske dimenzije Š/D/V	mm	800/275/553	820/338/614	890/340/700
Dimenzije sa ambalažom Š/D/V	mm	954/409/625	993/413/685	1046/460/780
Neto / bruto težina	kg	31.5/34	37.8/41.5	45/50
Radna tvar		R32	R32	R32
Promjer cijevi tekućinski	mm	6.35	6.35	9.52
Promjer cijevi plinski	mm	9.52	12.7	15.88
Maksimalna duljina cjevovoda	m	15	25	50
Maksimalna visinska razlika	m	10	15	30
Temperaturni raspon rada - hlađenje	°C	-10~43	-10~46	-20~46
Temperaturni raspon rada - grijanje	°C	-15~24	-15~24	-20~24



KANALNI MODEL SREDNJI ESP

Fleksibilna ugradnja i vrhunska sterilizacija zraka

Diskretno skrivena u strop, kanalna jedinica s raspoloživim statičkim tlakom 150 Pa olakšava korištenje jedinice zahvaljujući fleksibilnim cijevima raznih duljina.

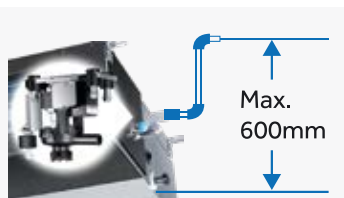

UVC sterilizacija

Ugrađeno UV LED svjetlo sterilizira zrak koji cirkulira klima uređajem. Učinkovito eliminira viruse i bakterije pri čemu isporučuje zdrav zrak u prostoriju.



Kanalni model srednji ESP



RASPOLOŽIVI
STATIČKI
TLAK
150 Pa



UVC
sterilizacija



Antibakterijski
filter



Wi-Fi



Ugrađena
pumpa
za odvod
kondenzata



SLIM dizajn
visina 248 mm



Super tihi
rad



Jednostavna
instalacija i
održavanje



(omogućuje
fleksibilnost
prilikom
projektiranja)



KANALNI MODEL	Unutarnja	AD35S2SM3FA(H)	AD50S2SM3FA(H)	AD71S2SM3FA(H)	AD105S2SM3FA(H)
	Vanjska	1U35S2SM1FA	1U50S2SJ2FA	1U71S2SR2FA	1U105S2SS2FA
Kapacitet - hlađenja	kW	3.50 (0.9-4.5)	5.0 (1.8-6)	7.1 (2.0-8.2)	9.50 (2.50-10.00)
Kapacitet - grijanje	kW	4.0 (1-4.8)	6.0 (2-6.2)	7.5 (2.5-8.5)	10.20 (3.00-10.50)
SEER/SCOP		6.1/3.8	6.1/4.0	6.1/3.8	6.10/3.80
Energetska klasa		A++/A	A++/A+	A++/A	A++/A
Unutarnja jedinica					
Napajanje	Ph/V/Hz	1/220~240/50/60	1/220~240/50/60	1/220~240/50/60	1/220~240/50/60
Protok zraka H/M/L	m³/h	840/720/600/450	1020/900/780/550	1440/1260/1100/900	1600/1480/1360
Razina buke - zvučna snaga H/M/L	dB(A)	55	56	58	61
Razina zvučnog tlaka H/M/L	dB(A)	41/35/28/26	43/37/30/28	44/41/39	47/44/40
Vanjske dimenzije Š/D/V	mm	700/700/248	1100/700/248	1100/700/248	1500/700/248
Neto / Bruto težina	kg	26/30	31/35	31/35	46/55
Daljinski	Opcija - bežični	YR-E17A	YR-E17A	YR-E17A	YR-E17A
	Opcija - žičani	YR-HQS01	YR-HQS01	YR-HQS01	YR-HQS01
Vanjska jedinica					
Napajanje	Ph/V/Hz	1/230/50	1/230/50	1/220~240/50/60	1/220~240/50/60
Protok zraka H/M/L	m³/h	2000	2500	3000	3500
Razina buke - zvučna snaga H/M/L	dB(A)	61	63	67	66
Razina zvučnog tlaka H/M/L	dB(A)	48	51	54	53
Vanjske dimenzije Š/D/V	mm	800/275/553	820/338/614	890/340/700	920/372/765
Dimenzije sa ambalažom Š/D/V	mm	954/409/625	993/413/685	1046/460/780	1036/478/820
Neto / bruto težina	kg	31.5/34	37.8/41.5	45/50	60/65
Radna tvar		R32	R32	R32	R32
Promjer cijevi tekućinski	mm	6.35	6.35	9.52	9.52
Promjer cijevi plinski	mm	9.52	12.7	15.88	15.88
Maksimalna duljina cjevovoda	m	15	25	50	50
Maksimalna visinska razlika	m	10	15	30	30
Temperaturni raspon rada - hlađenje	°C	-10~43	-10~46	-20~46	-20~46
Temperaturni raspon rada - grijanje	°C	-15~24	-15~24	-20~24	-20~24



KANALNI MODEL VISOKI ESP

Nevidljiva jedinica

Haier kanalne jedinice dizajnirane su kako bi se prilagodile prostorima s ograničenim opcijama za klimatizaciju.

Visoki protok zraka

Novi DC motor i produženi promjer ventilatora osiguravaju 2880 m³/h (800l/s), što je 44% više od srednjetačne kanalske jedinice.

Visoka učinkovitost

Istosmjerni motor ventilatora i izmjenjivač topline osigurava EER >3,4 za sve kombinacije visokotlačnih kanala.

Kapacitet	Protok zraka srednji tlak (m ³ /h)	Protok zraka visoki tlak (m ³ /h)	Poboljšani učinak
10.0kW	2000	2880	44%
12.5kW	2250	3250	44%
14.0kW	2500	3600	44%

Kanalni model visoki ESP



Ugrađena pumpa za odvod kondenzata



Kompaktni dizajn - visina 425 mm



Super tihi rad



Jednostavna instalacija i održavanje

RASPOLOŽIVI
STATIČKI
TLAK
do 210 Pa



(omogućuje fleksibilnost prilikom projektiranja)



KANALNI MODEL	Unutarnja	ADH125H1ERG	ADH140H1ERG	ADH160H1ERG
	Vanjska	1U125S2SN2FB	1U140S2SN1FB	1UH160P1ERG
Kapacitet - hlađenja	kW	12.4(3.0-13.0)	13.4(3.5-14.0)	15.00(4.50-16.00)
Kapacitet - grijanje	kW	12.8(3.5-13.5)	15.0(4.0-15.5)	16.00(5.00-17.00)
SEER/SCOP		5.9/3.97	5.98/3.97	5.60/4.00
Energetska klasa		A+/A	A+/A	A+/A +
Unutarnja jedinica				
Napajanje	Ph/V/Hz	1/220~240/50/60	1/220~240/50/60	1/220~240/50/60
Protok zraka H/M/L	m³/h	3250/2750/2250/1750	3600/3100/2600/2100	4000/3400/2800
Razina buke - zvučna snaga H/M/L	dB(A)	64	65	67
Razina zvučnog tlaka H/M/L	dB(A)	47/44/42/39	49/46/43/40	50/47/45/42
Vanjske dimenzije Š/D/V	mm	1350/490/425	1350/490/425	1350/490/425
Neto / Bruto težina	kg	61/72	61/72	61/72
Daljinski	Opcija - bežični	YR-HQS01	YR-HQS01	YR-HQS01
	Opcija - žičani	YR-E17A	YR-E17A	YR-E17A
Vanjska jedinica				
Napajanje	Ph/V/Hz	3/380-415/50/60	3/380-415/50/60	1/220-240/50/60
Protok zraka H/M/L	m³/h	4200	4200	7500
Razina buke - zvučna snaga H/M/L	dB(A)	72	72	73
Razina zvučnog tlaka H/M/L	dB(A)	58	58	57
Vanjske dimenzije Š/D/V	mm	950/370/965	950/370/965	1350/950/370
Dimenzije sa ambalažom Š/D/V	mm	1050/485/1130	1050/485/1130	1500/1090/480
Neto / bruto težina	kg	85/90	85/90	105/118
Radna tvar		R32	R32	R410A
Promjer cijevi tekućinski	mm	9.52	9.52	9.52
Promjer cijevi plinski	mm	15.88	15.88	15.88
Maksimalna duljina cjevovoda	m	50	70	75
Maksimalna visinska razlika	m	30	30	30
Temperaturni raspon rada - hlađenje	°C	-20~46	-20~46	-15~52
Temperaturni raspon rada - grijanje	°C	-20~24	-20~24	-20~24



PODNOSTROPNI MODEL

Moderan dizajn

Haier podno stropni model prilagođava se svakom prostoru s vrhunskim ispuhom zraka. Zrak se ravnomjerno raspoređuje u svakom kutu prostorije, kako bi se osigurala maksimalna udobnost. Jedinica se može postaviti na strop na visini od 4,2 m.

Antibakterijski filter

Antibakterijski filter sadrži ione srebra koje ima antiseptička svojstva za uništavanje širokog spektra bakterija s učinkovitošću do 99,99%.



Podnostropni model



KOMPAKTAN DIZAJN



Prilagođava se svakom prostoru npr. uskim ili kutnim prostorima



UVC sterilizacija



Antibakterijski filter



Wi-Fi



Elegantan i moderan dizajn



Super tihi rad 34 dB (A)



Jednostavna instalacija i održavanje



PODOSTROPNI MODEL	Unutarnja	AC35S2SG1FA(H)	AC50S2SG1FA(H)	AC71S2SG1FA(H)	AC105S2SH1FA(H)	AC125S2SK1FA(H)	AC140S2SK1FA(H)	AC160S2SK1FA(H)
	Vanjska	1U35S2SM1FA-2	1U50S2SJ2FA-2	1U71S2SR2FA	1U105S2SS1FA	1U125S2SN2FB	1U140S2SN1FB	1UH160P1ERG
Kapacitet - hlađenja	kW	3.5 (1.0-4.3)	5.0 (1.4-5.7)	7.1 (2-7.3)	9.5 (2.5-10.0)	12.4 (3.0-13.0)	13.4 (3.5-14.0)	16.00 (4.50-16.50)
Kapacitet - grijanje	kW	4.0 (1.0-5.3)	5.8 (1.4-6.0)	7.5 (2.5-8)	10.2 (3.0-10-5)	12.8 (3.5 - 13.5)	15.0 (4.0-15.5)	17.00 (5.00-18.00)
SEER/SCOP		8.5/4.47	7.31/4.1	6.1/3.8	6.1/3.8	5.86/3.98	5.97/4.0	6.06/4.06
Energetska klasa		A+++/A+	A++/A+	A++/A	A++/A	A+/A	A+/A+	A+/A+
Unutarnja jedinica								
Napajanje	Ph/V/Hz	1/220~240/50/60	1/220~240/50/60	1/220~240/50/60	1/220~240/50/60	1/220~230/50/60	1/220~240/50/60	1/220~240/50/60
Protok zraka H/M/L	m³/h	750/620/500	880/750/650	1250/1128/930/840	1600/1400/1280/1160	2050/1900/1600/1400	2150/1980/1800/1600	2250/2000/1850
Razina buke - zvučna snaga H/M/L	dB(A)	53	57	61	61	64	66	67
Razina zvučnog tlaka H/M/L	dB(A)	39/36/33	44/41/38	43/40/38	47/43/41	46/43/41/38	48/46/43/40	48/46/43
Vanjske dimenzije Š/D/V	mm	1000/230/680	1000/230/680	1325/230/680	1325/230/680	1650/230/680	1650/230/680	1650/230/680
Neto / Bruto težina	kg	26/32	26/32	33.5/41.9	33.5/41.9	43/51	43/51	43/51
Daljinski	Opcija - bežični	YR-HQS01	YR-HQS01	YR-HQS01	YR-HQS01	YR-HQS01	YR-HQS01	YR-HQS01
	Opcija - žičani	YR-E17A	YR-E17A	YR-E17A	YR-E17A	YR-E17A	YR-E17A	YR-E17A
Vanjska jedinica								
Napajanje	Ph/V/Hz	1/220~240/50/60	1/230/50	1/220~240/50/60	1/220~240/50/60	3/380-415/ 50/60	3/380-415/ 50/60	1/220-240/50/60
Protok zraka H/M/L	m³/h	2000	3000	3000	3500	4200	4200	7500
Razina buke - zvučna snaga H/M/L	dB(A)	61	63	67	66	72	72	73
Razina zvučnog tlaka H/M/L	dB(A)	48	50	54	53	58	58	57
Vanjske dimenzije Š/D/V	mm	800/275/553	820/305/643	890/340/700	920/372/760	950/370/965	950/370/965	1350/950/370
Dimenzije sa ambalažom Š/D/V	mm	908/405/625	940/390/697	1046/460/780	1036/478/820	1050/485/1130	1050/485/1130	1500/1090/480
Neto / bruto težina	kg	30/32.9	35.7/38.5	45/50	65/70	85/90	85/90	105/118
Radna tvar		R32	R32	R32	R32	R32	R32	R410A
Promjer cijevi tekućinski	mm	6.35	6.35	9.52	9.52	9.52	9.52	9.52
Promjer cijevi plinski	mm	9.52	12.7	15.88	15.88	15.88	15.88	15.88
Maksimalna duljina cjevovoda	m	20	25	50	50	50	70	75
Maksimalna visinska razlika	m	10	15	30	30	30	30	30
Temperaturni raspon rada - hlađenje	°C	-20~43	-20~43	-20~46	-10~46	-20~46	-20~46	-15~52
Temperaturni raspon rada - grijanje	°C	-20~24	-20~24	-20~24	-15~24	-20~24	-20~24	-20~24



PODNI INVERTER MODEL

Podni model s dvostrukim ispuhom zraka

Haier podni model prilagođava se svakom prostoru s vrhunskim ispuhom zraka. Zrak se ravnomjerno raspoređuje u svakom kutu prostorije, kako bi se osigurala maksimalna udobnost.

56°C sterilizacija

Ubija bakterije i viruse zagrijavanjem isparivača na visokih 56°C tijekom 30 minuta.

Antibakterijski filter

Antibakterijski filter sadrži ione srebra koje ima antiseptička svojstva za uništavanje širokog spektra bakterija s učinkovitošću do 99,99%.



Podni inverter model



Super tihi rad
20 dB (A)



Wi-Fi



Dupli ispuh
(gornja i
donja strana)



Jednostavna
instalacija i
održavanje
-podna i zidna
ugradnja



56°C
sterilizacija



Antibakterijski
filter

PODNA JEDINICA		Unutar.		AF25S2SD1FA(H)	AF35S2SD1FA(H)	AF42S2SD1FA(H)
		Vanjska		1U25S2SM1FA-2	1U35S2SM1FA-2	1U42S2SM1FA
HLADENJE	Kapacitet	Nominalno (Min.-Max.)	kW	2.5 (0.8-3.2)	3.4 (1.0-4.0)	4.20 (1.40-4.50)
	Energetska efikasnost / razred	SEER koeficijent	Ušteda energije	8.0 (A++)	7.5 (A++)	7.00 (A++)
	Snaga električnog priključka	Nominalno (Min.-Max.)	kW	0.65 (0.2-1.3)	0.94 (0.3-1.5)	1.30 (0.50-1.60)
	Temperaturni raspon rada (Hladenje)	Min. - Max.	°C	-20-43°C	-20-43°C	-20-43°C
GRIJANJE	Kapacitet	Nominalno (Min.-Max.)	kW	3.00 (0.80-3.80)	3.5 (1.1-4.5)	4.70 (1.40-5.00)
	Energetska efikasnost / razred	SCOP koeficijent	Ušteda energije	4.2 (A+)	4.2 (A+)	4.0 (A+)
	Snaga električnog priključka - grijanje	Nominalno (Min.-Max.)	kW	0.80 (0.30-1.6)	0.94 (0.5-1.6)	1.50 (0.60-1.90)
	Temperaturni raspon rada (Grijanje)	Min. - Max.	°C	-20-24°C	-20-24°C	-20-24°C
Napajanje		Ph/V/Hz		1/220-240/50/60	1/220-240/50/60	1/220-240/50/60
Napajanje (pozicija)				Vanjska (3x1.5)	Vanjska (3x1.5)	Vanjska (3x1.5)
Unutarnja jedinica						
Neto dimenzije		Š/D/V	mm	700/210/600	700/210/600	700/210/600
Dimenzije sa ambalažom		Š/D/V	mm	783/303/695	783/303/695	783/303/695
Neto / bruto težina			kg	16.5/18.5	16.5/18.5	16.5/18.5
Protok zraka		Max.	m³/h	400/350/300	450/400/350	530/480/430
Odvlaživanje			lit/h	1.2	1.6	1.8
Razina buke - zvučni tlak		(H/Mid/Lo/So)	db(A)	40/32/25/20	42/34/26/21	46/37/33
Vanjska jedinica						
Neto dimenzije		Š/D/V	mm	800/275/553	800/275/553	800/275/553
Dimenzije sa ambalažom		Š/D/V	mm	908/405/625	908/405/625	954/409/625
Neto / bruto težina			kg	27.6/30.4	30/32.9	31.5/34
Protok zraka		Max.	m³/h	1900	2000	2100
Razina buke - zvučni tlak		Hi/Lo	db(A)	47	48	50
Vrsta radne tvari				R32	R32	R32
Količina radne tvari			g	630	780	940
Dodatna količina radne tvari			g/m	20	20	20
Promjeri cijevi	Tekućinski		mm	6.35	6.35	6.35
	Plinski		mm	9.52	9.52	9.52
	Max. dozvoljena duljina cjevovoda		m	20	20	20
	Max. duljina cjevovoda bez nadoknade		m	7	7	7
	Nadoknada po dodatnom metru		g/m	20	20	20
	Max. visinska razlika		m	10	10	10
Međuveza			mm²	4x1.5	4x1.5	4x1.5
Razmak nogica			mm	510	510	510

Haier

MRV SISTEMI





MRV5-H
DC INVERTER

Haier

Neprekidno grijanje, neprekidna udobnost



Kompresor EVI

poboljšana energetska učinkovitost za 30%

Neprekidno grijanje

inteligentna tehnika odležavanja

Dvostupanjska tehnika pothlađivanja

poboljšani rashladni i toplinski učini

Supervodljiva tehnika hlađenja radne tvari

osiguran pouzdan rad elemenata elektroničke regulacije



MRV sustavi

unutarnje jedinice



ZIDNI MODELI	Kapacitet (kW)		Protok zraka (m ³ /h)	Razina buke dB(A)	Neto dimenzija ŠxDxV (mm)	Neto/Bruto težina (kg)	Promjeri cijevi mm (")		Daljinski upravljač (S - standard, O - opcija)	
	Hlađenje	Grijanje					Tekućinski vod (tlačni)	Plinski vod (usisni)	Žičani	Infracrveni
AS072MNERAB	2,2	2,5	550/480/420	35/31/29	855x208x280	9,9/12	6,35	9,52	O	O
AS092MNERAB	2,8	3,2	600/530/470	36/31/29	855x208x280	9,9/12	6,35	9,52	O	O
AS122MNERAB	3,6	4,0	630/560/500	37/33/29	855x208x280	9,9/12	6,35	9,52	O	O
AS182MNERA	5,6	6,3	920/800/720	40/39/35	1115x243x336	15,8/18,9	9,52	12,7	O	O
AS242MNERA	7,1	8,0	1010/920/800	44/40/36	1115x243x336	15,8/18,9	9,52	15,88	O	O
AS052MNERAB	1,5	1,7	500/430/370	33/31/29	855x208x280	9,9/12	6,35	9,52	O	O
AS072MNERAB	2,2	2,5	550/480/420	35/31/29	855x208x280	9,9/12	6,35	9,52	O	O
AS092MNERAB	2,8	3,2	600/530/470	36/31/29	855x208x280	9,9/12	6,35	9,52	O	O
AS122MNERAB	3,6	4,0	630/560/500	37/33/29	855x208x280	9,9/12	6,35	9,52	O	O
AS162MNERA	4,5	5,0	800/720/650	39/36/34	1115x243x336	18,5/18,9	6,35	12,7	O	O
AS182MNERA	5,6	6,3	920/800/720	40/39/35	1115x243x336	18,5/18,9	6,35	12,7	O	O
AS242MNERA	7,1	8,0	1010/920/800	44/40/36	1115x243x336	18,5/18,9	6,35	15,88	O	O
AS282MNERA	8,0	9,0	1500/1400/1300	48/43/40	1316x270x365	21,8/26,3	9,52	15,88	O	O
AS302MNERA	9,0	10,0	1600/1500/1400	49/44/41	1316x270x365	21,8/26,3	9,52	15,88	O	O

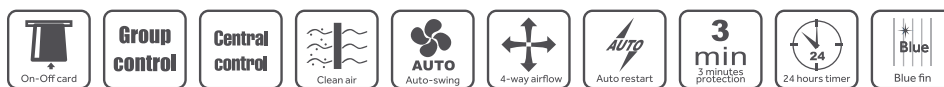
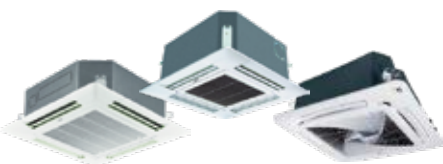

4-SMJERNI KAZETNI MODELI	Kapacitet (kW)		Protok zraka (m ³ /h)	Razina buke dB(A)	Neto dimenzija ŠxDxV (mm)	Neto/Bruto težina (kg)	Promjeri cijevi mm (")		Daljinski upravljač (S - standard, O - opcija)		Panel
	Hlađenje	Grijanje					Tekućinski vod (tlačni)	Plinski vod (usisni)	Žičani	Infracrveni	
AB052MCERA (M)	1,5	1,7	520/450/400	32/30/29	570x570x260	16/19	6,35	9,52	O	O	PB-620KB
AB022MCERA (M)	2,2	2,5	520/450/400	32/30/29	570x570x260	16/19	6,35	9,52	O	O	PB-620KB
AB092MCERA (M)	2,8	3,2	520/450/400	32/30/29	570x570x260	16/19	6,35	9,52	O	O	PB-620KB
AB122MCERA (M)	3,6	4,0	520/450/400	32/30/29	570x570x260	19/22	6,35	12,7	O	O	PB-620KB
AB162MCERA (M)	4,5	5,0	650/520/450	32/30/29	570x570x260	19/22	6,35	12,7	O	O	PB-620KB
AB182MCERA (M)	5,6	6,3	760/650/520	34/32/30	570x570x260	19/22	6,35	12,7	O	O	PB-620KB
AB052MCERA	1,5	1,7	650/540/430	31/29/28	570x570x260	16/19	6,35	9,52	O	O	PB-700IB
AB072MCERA	2,2	2,5	700/590/480	32/30/29	570x570x260	16/20	6,35	9,52	O	O	PB-700IB
AB092MCERA	2,8	3,2	700/590/480	32/30/29	570x570x260	16/21	6,35	9,52	O	O	PB-700IB
AB122MCERA	3,6	4,0	700/590/480	32/30/29	570x570x260	16/22	6,35	12,7	O	O	PB-700IB
AB162MCERA	4,5	5,0	700/590/480	33/30/29	570x570x260	19/22	6,35	12,7	O	O	PB-700IB
AB182MCERA	5,6	6,3	700/590/480	33/30/29	840x840x240	19/22	6,35	12,7	O	O	PB-950JB
AB242MRERA	7,1	8,0	1380/1190/1000	35/34/31	840x840x204	27/30	9,52	15,88	O	O	PB-950JB
AB282MRERA	8,0	9,0	1380/1190/1000	37/35/31	840x840x204	27/30	9,52	15,88	O	O	PB-950JB
AB302MRERA	9,0	10,0	2050/1860/1670	37/35/31	840x840x246	31/36	9,52	15,88	O	O	PB-950JB
AB382MRERA	11,2	12,5	2050/1860/1670	37/35/31	840x840x288	33/38	9,52	15,88	O	O	PB-950JB
AB482MRERA	14,0	16,0	2100/1910/1720	44/40/36	840x840x288	33/38	9,52	15,88	O	O	PB-950JB
AB072MRERA	2,2	2,5	1000/810/620	30/27/25	840x840x183	25/28	6,35	9,52	O	O	PB-950KB
AB092MRERA	2,8	3,2	1000/810/620	30/27/25	840x840x183	25/28	6,35	9,52	O	O	PB-950KB
AB122MRERA	3,6	4,0	1000/810/620	30/27/25	840x840x183	25/28	6,35	12,7	O	O	PB-950KB
AB162MRERA	4,5	5,0	1000/810/620	32/29/27	840x840x183	25/28	6,35	12,7	O	O	PB-950KB
AB182MRERA	5,6	6,3	1000/810/620	33/30/29	840x840x183	25/28	6,35	12,7	O	O	PB-950KB
AB242MRERA	7,1	8,0	1380/1190/1000	35/34/31	840x840x204	27/30	9,52	15,88	O	O	PB-950KB
AB282MRERA	8,0	9,0	1380/1190/1000	37/35/31	840x840x204	27/30	9,52	15,88	O	O	PB-950KB
AB302MRERA	9,0	10,0	2050/1860/1670	37/35/31	840x840x246	31/36	9,52	15,88	O	O	PB-950KB
AB382MRERA	11,2	12,5	2050/1860/1670	37/35/31	840x840x246	31/36	9,52	15,88	O	O	PB-950KB
AB482MRERA	14,0	16,0	2100/1910/1720	44/40/36	840x840x288	33/38	9,52	15,88	O	O	PB-950KB
AB602MRERA	16,0	18,0	2100/1910/1720	44/40/36	840x840x288	33/38	9,52	15,88	O	O	PB-950KB

MRV sustavi

unutarnje jedinice



JEDNOSMJERNI KAZETNI MODELI	Kapacitet (kW)		Protok zraka (m ³ /h)	Razina buke dB(A)	Neto dimenzija ŠxDxV (mm)	Neto/Bruto težina (kg)	Promjeri cijevi mm (")		Daljinski upravljač (S - standard, O - opcija)		Panel
	Hlađenje	Grijanje					Tekućinski vod (tlačni)	Plinski vod (usisni)	Žičani	Infracrveni	
AB052MAERA	1,5	1,7	530/490/450	32/29/24	875x505x185	15,3/17,9	6,35	9,52	O	O	P1B-1050IB
AB072MAERA	2,2	2,5	530/490/450	32/29/24	875x505x185	15,3/17,9	6,35	9,52	O	O	P1B-1050IB
AB092MAERA	2,8	3,2	530/490/450	32/29/24	875x505x185	15,3/17,9	6,35	9,52	O	O	P1B-1050IB
AB122MAERA	3,6	4,0	550/530/490	34/30/25	875x505x185	15,3/17,9	6,35	12,7	O	O	P1B-1050IB



2-SMJERNI KAZETNI MODELI	Kapacitet (kW)		Protok zraka (m ³ /h)	Razina buke dB(A)	Neto dimenzija ŠxDxV (mm)	Neto/Bruto težina (kg)	Promjeri cijevi mm (")		Daljinski upravljač (S - standard, O - opcija)		Panel
	Hlađenje	Grijanje					Tekućinski vod (tlačni)	Plinski vod (usisni)	Žičani	Infracrveni	
AB072MBERA	2,2	2,5	840/700/550	42/37/33	817x620x220	21/23	6,35	9,52	O	O	P2B-1055IB
AB092MBERA	2,8	3,2	840/700/550	42/37/33	817x620x220	21/23	6,35	9,52	O	O	P2B-1055IB
AB122MBERA	3,6	4,0	840/700/550	42/37/33	817x620x220	21/23	6,35	12,7	O	O	P2B-1055IB
AB162MBERA	4,5	5,0	840/700/550	44/39/34	817x620x220	21/23	6,35	12,7	O	O	P2B-1055IB
AB182MBERA	5,6	6,3	840/700/550	44/39/34	817x620x220	21/23	6,35	12,7	O	O	P2B-1055IB



PODNO STROPNI MODELI	Kapacitet (kW)		Protok zraka (m ³ /h)	Razina buke dB(A)	Neto dimenzija ŠxDxV (mm)	Neto/Bruto težina (kg)	Promjeri cijevi mm (")		Daljinski upravljač (S - standard, O - opcija)	
	Hlađenje	Grijanje					Tekućinski vod (tlačni)	Plinski vod (usisni)	Žičani	Infracrveni
AC092MDERA	2,8	3,2	820/750/690	38/36/34	1000x230x680	27,9/33,6	6,35	9,52	O	O
AC122MDERA	3,6	4,0	820/750/690	38/36/34	1000x230x680	27,9/33,6	6,35	12,7	O	O
AC162MDERA	4,5	5,0	950/820/690	42/38/35	1000x230x680	27,9/33,6	6,35	12,7	O	O
AC182MDERA	5,6	6,3	950/820/690	42/38/35	1000x230x680	27,9/33,6	6,35	12,7	O	O
AC242MDERA	7,1	8,0	1420/1270/1240	46/44/41	1325x230x680	35,8/42,1	6,35	15,88	O	O
AC282MDERA	8,0	9,0	1570/1420/1240	47/44/41	1325x230x680	35,8/42,1	9,52	15,88	O	O
AC302MDERA	9,0	10,0	1570/1420/1240	47/44/41	1325x230x680	35,8/42,1	9,52	15,88	O	O
AC382MDERA	11,2	12,5	2110/1990/1750	50/46/43	1650x230x680	43,5/50,5	9,52	15,88	O	O
AC482MDERA	14,0	16,0	2110/1990/1750	50/46/43	1650x230x680	43,5/50,5	9,52	15,88	O	O



PODNI MODELI	Kapacitet (kW)		Protok zraka (m ³ /h)	Razina buke dB(A)	Neto dimenzija ŠxDxV (mm)	Neto/Bruto težina (kg)	Promjeri cijevi mm (")		Daljinski upravljač (S - standard, O - opcija)	
	Hlađenje	Grijanje					Tekućinski vod (tlačni)	Plinski vod (usisni)	Žičani	Infracrveni
AF052MBERA	1,5	1,7	540/460/390/310/270	45/42/38/33/30	700x210x600	15,2/18,7	6,35	12,7	O	O
AF072MBERA	2,2	2,5	540/460/390/310/270	45/42/38/33/30	700x210x600	15,2/18,7	6,35	12,7	O	O
AF092MBERA	2,8	3,2	540/460/390/310/270	45/42/38/33/30	700x210x600	15,2/18,7	6,35	12,7	O	O
AF122MBERA	3,6	4,0	580/500/420/350/270	47/44/40/36/30	700x210x600	15,2/18,7	6,35	12,7	O	O
AF182MBERA	5,0	5,5	620/540/460/390/270	48/45/42/38/30	700x210x600	15,2/18,7	6,35	12,7	O	O

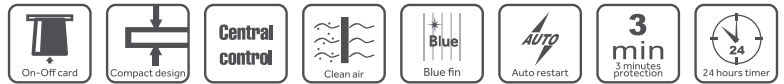

PODNO SAKRIVENI MODELI	Kapacitet (kW)		Protok zraka (m ³ /h)	Razina buke dB(A)	Neto dimenzija ŠxDxV (mm)	Neto/Bruto težina (kg)	Promjeri cijevi mm (")		Daljnji upravljač (S - standard, O - opcija)	
	Hladenje	Grijanje					Tekućinski vod (tlačni)	Plinski vod (usisni)	Žičani	Infracrveni
AE072MLERA	2.2	2.5	750/650/550	38/35/33	1116x221x624	29/37	6.35	9.52	O	O
AE092MLERA	2.8	3.2	750/650/550	38/35/33	1116x221x624	29/37	6.35	12.7	O	O
AE122MLERA	3.6	4.0	750/650/550	40/37/35	1116x221x624	29/37	6.35	12.7	O	O
AE162MLERA	4.5	5.0	950/830/720	40/37/35	1116x221x624	31/39	6.35	12.7	O	O
AE182MLERA	5.6	6.3	950/830/720	42/39/36	1116x221x624	31/39	6.35	12.7	O	O
AE242MLERA	7.1	8.0	950/830/720	42/39/36	1116x221x624	31/39	6.35	15.88	O	O



KANALNI MODELI 30 Pa	Kapacitet (kW)		Protok zraka (m ³ /h)	Razina buke dB(A)	Neto dimenzija ŠxDxV (mm)	Neto/Bruto težina (kg)	Promjeri cijevi mm (")		Daljnji upravljač (S - standard, O - opcija)		Panel
	Hladenje	Grijanje					Tekućinski vod (tlačni)	Plinski vod (usisni)	Žičani	Infracrveni	
AD052MSERA	1.5	1.7	430/370/310	26/22/19	850x420x185	16.5/21.5	6.35	9.52	O	O	P1B-890IA
AD072MSERA	2.2	2.5	480/420/360	27/23/20	850x420x185	17.5/22.5	6.35	9.52	O	O	P1B-890IA
AD092MSERA	2.8	3.2	480/420/360	27/23/20	850x420x185	17.5/22.5	6.35	12.7	O	O	P1B-890IA
AD122MSERA (D)	3.6	4.0	550/430/370	30/27/24	850x420x185	17.5/22.5	6.35	12.7	O	O	P1B-890IA
AD162MSERA (D)	4.5	5.0	600/540/460	32/29/26	850x420x185	18.5/23.5	6.35	12.7	O	O	P1B-890IA
AD182MSERA (D)	5.6	6.3	800/690/580	33/30/27	1170x420x185	22.2/28.2	6.35	12.7	O	O	P1B-12102IA
AD242MSERA	7.1	8.0	930/850/750	36/33/30	1170x420x185	24/30	9.52	15.88	O	O	P1B-12102IA

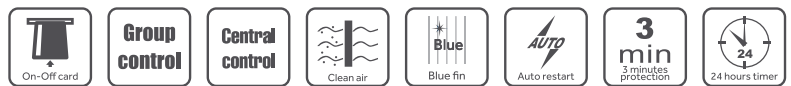

KANALNI MODELI 96 Pa	Kapacitet (kW)		Protok zraka (m ³ /h)	Razina buke dB(A)	Neto dimenzija ŠxDxV (mm)	Neto/Bruto težina (kg)	Promjeri cijevi mm (")		Daljnji upravljač (S - standard, O - opcija)	
	Hladenje	Grijanje					Tekućinski vod (tlačni)	Plinski vod (usisni)	Žičani	Infracrveni
AD182MSERA(H)	5.6	7.1	800/690/580	33/30/27	1170x420x185	22.2/28.2	6.35	12.7	O	O
AD242MSERA(H)	7.1	8.0	930/850/750	36/33/30	1170x420x185	24/30	6.35	15.88	O	O
AD282MJERA(H)	8.0	9.0	1100/700/248	35/33/30	1100x700x248	36.8/43.4	9.52	15.88	O	O
AD302MJERA(H)	9.0	10.0	1100/700/248	36/33/30	1100x700x248	39.4/45.4	9.52	15.88	O	O
AD382MJERA(H)	11.2	13.0	1500/700/248	38/35/32	1500x700x248	48.3/56.5	9.52	15.88	O	O
AD482MJERA(H)	14.0	16.3	1500/700/248	40/36/32	1500x700x248	51.3/59.5	9.52	15.88	O	O

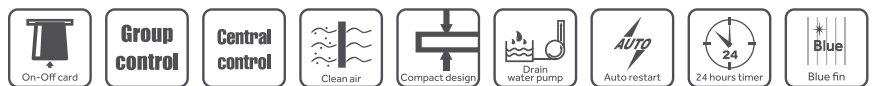

KANALNI MODELI 100 Pa	Kapacitet (kW)		Protok zraka (m ³ /h)	Razina buke dB(A)	Neto dimenzija ŠxDxV (mm)	Neto/Bruto težina (kg)	Promjeri cijevi mm (")		Daljnji upravljač (S - standard, O - opcija)	
	Hladenje	Grijanje					Tekućinski vod (tlačni)	Plinski vod (usisni)	Žičani	Infracrveni
AD182MJERAB	5.6	6.3	980/840/760	36/34/32	1100x700x248	36.8/43.5	6.35	12.7	O	O
AD242MJERAB	7.1	8.0	1174/1080/960	40/37/34	1100x700x248	37/43.4	9.52	15.88	O	O
AD282MJERAB	8.0	9.0	1174/1080/960	42/38/34	1100x700x248	37/43.4	9.52	15.88	O	O
AD302MJERA	9.0	10.0	1500/1180/930	42/38/34	1100x700x248	39.4/45.4	9.52	15.88	O	O
AD382MJERA	11.2	13.0	1700/1300/900	42/39/35	1500x700x248	48.3/56.5	9.52	15.88	O	O
AD482MJERA	14.0	16.3	2000/1700/1250	43/40/35	1500x700x248	51.3/59.5	9.52	15.88	O	O
AD542MJERA	16.0	18.0	2000/1700/1250	43/40/35	1500x700x248	51.3/59.5	9.52	15.88	O	O

MRV sustavi

unutarnje jedinice



KANALNI MODELI ZA SVJEŽI ZRAK	Kapacitet (kW)		Protok zraka (m ³ /h)	Razina buke dB(A)	Neto dimenzija ŠxDxV(mm)	Neto/Bruto težina (kg)	Promjeri cijevi mm (")		Daljinski upravljač (S - standard, O - opcija)	
	Hlađenje	Grijanje					Tekućinski vod (tlačni)	Plinski vod (usisni)	Žičani	Infracrveni
AD482MPERA	14,0	8,9	1600/1460/1070	48/47/42	1355x876x360	62/77	9,52 (3/8)	15,88 (5/8)	O	O
AD722MPERA	22,6	15,2	2300/1900/1320	55/53/50	1725x876x360	92/100	9,52 (3/8)	25,4 (1)	O	O
AD962MPERA	28,0	17,8	2800/2400/1820	55/53/4/52	1725x876x360	92/100	9,52 (3/8)	25,4 (1)	O	O



vanjske jedinice

VANJSKE JEDINICE III	Kapacitet (kW)		Protok zraka (m ³ /h)	Razina buke dB(A)	Neto dimenzija ŠxDxV (mm)	Neto/Bruto težina (kg)	Promjeri cijevi mm (")		Količina	Max. visinska razlika (m)	Max. dozvoljena duljina cijevi (m)
	Hlađenje nom (min-max)	Grijanje nom (min-max)					Tekućinski vod (tlačni)	Plinski vod (usisni)			
AU282FHIERA (H)	8,0	9,5	3500	54	960x380x830	70/76	9,52 (3/8)	15,88 (5/8)	2,6	30	50
AU482FHIERA(G)	15,0	17,0	6500	59	960x380x1250	120	9,52 (3/8)	19,05 (3/4)	3,6	30	100
AU48NFIERA(H)	15,0	17,0	6500	58	960x340x1250	99/107	9,52 (3/8)	19,05 (3/4)	4	30	100
AU60NFIERA(H)	18,0	20,0	6500	59	960x340x1250	99/107	9,52 (3/8)	19,05 (3/4)	4	30	100
AV08NMSETA	22,6	25,0	10000	56	1050x400x1620	240/260	9,52 (3/8)	19,05 (3/4)	6,6	50	300
AV10NMSETA	28,0	31,5	10000	58	1050x400x1620	240/260	12,7 (1/2)	22,22 (7/8)	6,6	50	300
AV12NMSETA	33,5	37,5	10000	60	1050x400x1620	360/380	12,7 (1/2)	25,4 (1)	6,6	50	300
AV08NMVESA	22,6	25,0	11100	57	990x750x1808	240/260	9,52 (3/8)	19,05 (3/4)	10	50	300
AV10NMVESA	28,0	31,5	11100	57	990x750x1808	240/260	9,52 (3/8)	22,22 (7/8)	11	50	300
AV12IMVESA	33,5	37,5	14100	60	1390x750x1808	360/380	12,7 (1/2)	25,4 (1)	12	50	300
AV14IMVESA	40,0	45,0	14100	60	1390x750x1808	360/380	12,7 (1/2)	25,4 (1)	12	50	300
AV16IMVESA	45,0	50,0	14100	60	1390x750x1808	368/393	12,7 (1/2)	28,58 (1 1/8)	14,5	50	300

Temperaturni raspon: hlađenje od -5 °C do +43 °C, grijanje od -15 °C do +21 °C

VANJSKE JEDINICE IV											
AV08NMMEUA	25,2	27,3	15000	57	720x1350x1690	276/301	9,52 (3/8)	19,05 (3/4)	9,7	110	1000
AV10NMMEUA	28,0	31,5	15000	57	720x1350x1690	276/301	9,52 (3/8)	22,22 (7/8)	9,7	110	1000
AV12NMMEUA	33,5	37,5	15000	59	720x1350x1690	276/301	12,7 (1/2)	25,4 (1)	9,7	110	1000
AV14NMMEUA	40,0	45,0	15000	59,5	720x1350x1690	279/304	12,7 (1/2)	28,58 (1 1/8)	10	110	1000
AV16NMMEUA	45,0	50,0	15600	61	720x1350x1690	321/346	12,7 (1/2)	28,58 (1 1/8)	10	110	1000
AV18NMMEUA	50,4	56,5	16200	62	720x1350x2048	335/360	12,7 (1/2)	28,58 (1 1/8)	10	110	1000
AV20NMMEUA	56,0	63,0	16200	62	720x1350x2048	335/360	12,7 (1/2)	28,58 (1 1/8)	10	110	1000
AV22NMMEUA	61,5	69,0	16200	62	720x1350x2048	359/384	12,7 (1/2)	28,58 (1 1/8)	10	110	1000
AV24NMMEUA	68,0	73,0	16200	63	720x1350x2048	359/384	12,7 (1/2)	28,58 (1 1/8)	10	110	1000

Temperaturni raspon: hlađenje od -5 °C do +53 °C, grijanje od -23 °C do +23 °C

VANJSKE JEDINICE V	Kapacitet (kW)		Protok zraka (m ³ /h)	Razina buke dB(A)	Neto dimenzija ŠxDxV (mm)	Neto/Bruto težina (kg)	Promjeri cijevi mm (")		Količina	Max. visinska razlika (m)	Max. dozvoljena duljina cijevi (m)
	Hlađenje nom (min-max)	Grijanje nom (min-max)					Tekućinski vod (tlačni)	Plinski vod (usisni)			
AV08IMVEVA	25,2	25,2	11000	56	980x750x1690	224/250	9,52	19,05	8,5	110	1000
AV10IMVEVA	28,0	28,0	11000	56	980x750x1690	224/250	9,52	22,22	8,5	110	1000
AV12IMVEVA	33,5	33,5	12000	59	980x750x1690	224/250	12,7	25,4	8,5	110	1000
AV14IMVEVA	40,0	40,0	13500	59	980x750x1690	244/270	12,7	25,4	10	110	1000
AV16IMVEVA	45,0	45,0	13500	60	980x750x1690	244/270	12,7	28,58	10	110	1000
AV18IMVEVA	50,4	50,4	17000	61	1410x750x1690	287/317	15,88	28,58	10	110	1000
AV20IMVEVA	56,0	56,0	17000	61	1410x750x1690	370/400	15,88	28,58	10	110	1000
AV22IMVEVA	61,5	61,5	18000	61	1410x750x1690	370/400	15,88	28,58	10	110	1000
AV24IMVEVA	68,0	68,0	18000	62	1410x750x1690	370/400	15,88	28,58	10	110	1000
AV26IMVEVA	73,5	73,5	19000	62	1410x750x1690	370/400	15,88	28,58	10	110	1000

Temperaturni raspon: hlađenje od -5 °C do +50 °C, grijanje od -23 °C do +21 °C

VANJSKE JEDINICE V-H											
AV08NMVETA	25,2	25,2	11000	56	980x750x1690	225/280	9,52	19,05	10	110	1000
AV10NMVETA	28,0	28,0	11000	56	980x750x1690	225/280	9,52	22,22	10	110	1000
AV12NMVETA	33,5	33,5	12000	59	980x750x1690	225/280	12,7	25,4	10	110	1000
AV14NMVETA	40,0	40,0	13500	59	980x750x1690	225/280	12,7	25,4	10	110	1000
AV16NMVETA	45,0	45,0	13500	60	980x750x1690	225/280	12,7	28,58	10	110	1000
AV18NMVETA	50,4	50,4	17000	61	1410x750x1690	385/410	15,88	28,58	10	110	1000
AV20NMVETA	56,0	56,0	17000	61	1410x750x1690	385/410	15,88	28,58	10	110	1000
AV22NMVETA	61,5	61,5	18000	61	1410x750x1690	385/410	15,88	28,58	10	110	1000
AV24NMVETA	68,0	68,0	18000	62	1410x750x1690	385/410	15,88	28,58	10	110	1000
AV26NMVETA	73,5	73,5	19000	62	1410x750x1690	385/410	15,88	28,58	10	110	1000

Temperaturni raspon: hlađenje od -5 °C do +52 °C, grijanje od -27 °C do +21 °C

VANJSKE JEDINICE V-RC											
AV08IMVURA	22,4	22,4	12000	57	980x750x1690	246/271	9,52	19,05	10	110	1000
AV10IMVURA	28,0	28,0	12000	58	980x750x1690	246/271	9,52	22,22	10	110	1000
AV12IMVURA	33,5	33,5	13500	60	980x750x1690	257/282	12,7	25,4	10	110	1000
AV14IMVURA	40,0	40,0	13500	61	980x750x1690	257/282	12,7	25,4	10	110	1000
AV16IMVURA	45,0	45,0	17000	62	1410x750x1690	366/395	12,7	28,58	10	110	1000
AV18IMVURA	50,4	50,4	17000	63	1410x750x1690	366/395	15,88	28,58	10	110	1000
AV20IMVURA	56,0	56,0	19000	63	1410x750x1690	375/404	15,88	28,58	10	110	1000
AV22IMVURA	60,0	60,0	19000	64	1410x750x1690	375/404	15,88	28,58	10	110	1000















Temperaturni raspon: hlađenje od -5 °C do +50 °C, grijanje od -23 °C do +21 °C

MB Frigo Grupa ima preko 40 godina iskustva u području klimatizacije te sa stručnim timom osigurava kvalitetno rješenje u prostorima različitih namjena u cjelokupnom projektu ili u pojedinoj fazi izvedbe projekta.

- konzultacije u pripremi projekata kao i u svim fazama razrade projekta
- pomoć pri odabiru optimalnog rješenja
- stručno savjetovanje pri odabiru opreme
- brza isporuka opreme u traženom roku
- servisa i tehnička podrška pri montaži i puštanju u pogon
- veliki lager rezervnih dijelova
- stručno savjetovanje i tehnička podrška prilikom održavanja montirane opreme



Upravljanje

Upravljanje	Dizajn	Model	Funkcije
Infracrveni daljinski		YR-HQS01	<ul style="list-style-type: none"> * On/Off, odabir načina rada, brzina ventilatora, podešavanje temperature, određivanje smjera ispuha * Turbo način rada, tiši rada * Kontrola lamela za ispuh kod kazetnih jedinica * Prikaz vremena i timer * Podešavanje funkcija za zdravlje * Frost Clean * Pozadinsko svjetlo * Pogodno za upravljanje većinom funkcija putem jednog gumba
		YR-HRS01	<ul style="list-style-type: none"> * On/Off, odabir načina rada, brzina ventilatora, podešavanje temperature, određivanje smjera ispuha * Turbo način rada, tiši rada * Kontrola lamela za ispuh kod kazetnih jedinica * Frost Clean * Timer * Podešavanje funkcija za zdravlje * Pozadinsko svjetlo
Žičani daljinski		YR-E16B	<ul style="list-style-type: none"> * Display u boji * On/Off, odabir načina rada, brzina ventilatora, podešavanje temperature, određivanje smjera ispuha * Individualna i grupna kontrola (do 16 unutarnjih jedinica) * Precizna kontrola odabira temperature 0,5 °C * Tjedni timer * Individualna kontrola za kazete * Postavke statičkog tlaka
		YR-E17A	<ul style="list-style-type: none"> * Touch screen * On/Off, odabir načina rada, brzina ventilatora, podešavanje temperature, određivanje smjera ispuha * Individualna i grupna kontrola (do 16 unutarnjih jedinica) * Precizna kontrola odabira temperature 0,5 °C * Jednostavan i kompaktan dizajn (86x86x13,05 mm) * Pozadinsko svjetlo * Prikaz vremena i timer * Jednostavna ugradnja * Individualna kontrola za kazete * Postavke statičkog tlaka * Ugrađeni infracrveni prijemnik signala za kanalne jedinice za korištenje infracrvenog daljinskog
		HW-BA116ABK	<ul style="list-style-type: none"> * On/Off, odabir načina rada, brzina ventilatora, podešavanje temperature, određivanje smjera ispuha * Individualna i grupna kontrola (do 16 unutarnjih jedinica) * Jednostavan i kompaktan dizajn (86x86x14,80 mm) * Ugrađeni infracrveni prijemnik signala za kanalne jedinice za korištenje infracrvenog daljinskog
		HW-BA101ABT	<ul style="list-style-type: none"> * Individualna i grupna kontrola (do 16 unutarnjih jedinica) * Touch screen * Kaljeno staklo s istaknutim LED zaslonom * On/Off, odabir načina rada, brzina ventilatora, podešavanje temperature, određivanje smjera ispuha * Ugrađeni infracrveni prijemnik signala za kanalne jedinice za korištenje infracrvenog daljinskog
Centralni daljinski		YCZ-A004	<ul style="list-style-type: none"> * Individualna, grupna i centralna kontrola (do 256 unutarnjih jedinica) * 7-inch TFT LCD touch screen * Tjedni timer * Dostupne informacije o unutarnjim jedinicama * Sigurnosna kopija povijesnih podataka * Za komercijalnu seriju potrebni su dodaci PCB adapter i YCJ-A002
		HC-SA164DBT	<ul style="list-style-type: none"> * Individualna, grupna i centralna kontrola (do 64 unutarnje jedinice) * 5-inch TFT LCD touch screen * Tjedni timer * Pohrana podataka o greškama i izvješćivanje * Za komercijalnu seriju potrebni su dodaci PCB adapter i YCJ-A002
		HC-LA1CDBT	<ul style="list-style-type: none"> * 12.5 -inch TFT LCD touch screen * Individualna, grupna i centralna kontrola (do 128 unutarnjih jedinica komercijalne serije) * Tlocrtni prikaz etaža * Web pristup i alarm putem e-maila * Tjedni i dnevni timer * Integrirana opcija za spajanje s drugim uređajima (npr. požarni sustav) * Za komercijalnu seriju potrebni su dodaci PCB adapter i YCJ-A002 * Multijezična opcija
Prijemnik žičanog daljinskog		RE-02	<ul style="list-style-type: none"> * Infracrveni prijemnik za kanalne jedinice
Modul		YCJ-A002	<ul style="list-style-type: none"> Modul za spajanje supermatch unutarnjih jedinica na centralni daljinski. Spajanje Wi-Fi modula na uređaj koji nema pripremu za Wi-Fi (kanalne i kazetne). Omogućuje naizmjenično paljenje/gašenje uređaja po radnim satima i greškama.
		WK-B	<ul style="list-style-type: none"> Omogućuje spajanje zidnih jedinica kućne serije na žičani daljinski upravljač.
		HA-MA1ADB	<ul style="list-style-type: none"> Omogućuje spajanje MRV sustava na centralni daljinski upravljač HC- LA1CDBT.
		HA-MA164AD	<ul style="list-style-type: none"> Omogućuje spajanje MRV sustava na centralni daljinski upravljač HC- SA164DBT i YCZ-A004.

Dimenzije unutarnjih jedinica



Jade Super Match

AS25S2SJ1FA-3/AS35S2SJ1FA-3

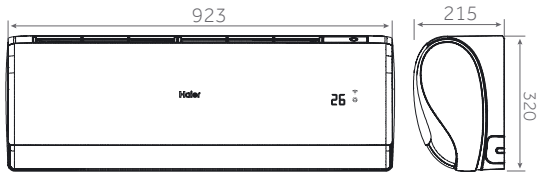

AS50S2SJ1FA-3

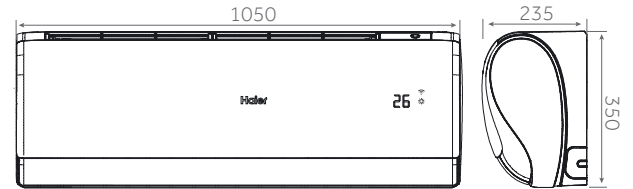

Expert - Nordic

AS25XCHHRA-NR/AS35XCHHRA-NR

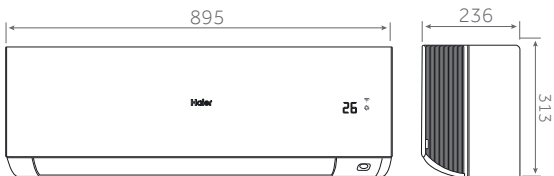

Expert

AS25XCAHRA/AS35XCAHRA/AS50XCAHRA

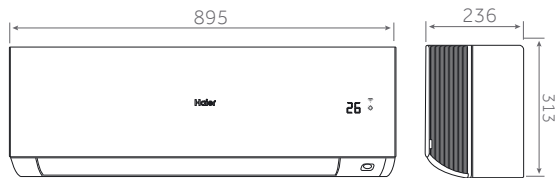

Flexis Plus

AS25S2SF1FA-BH / AS35S2SF1FA-BH
AS25S2SF1FA-S / AS35S2SF1FA-S
AS25S2SF1FA-WH / AS35S2SF1FA-WH



AS50S2SF1FA-BH / AS50S2SF1FA-WH



AS71S2SF1FA-BH / AS71S2SF1FA-WH

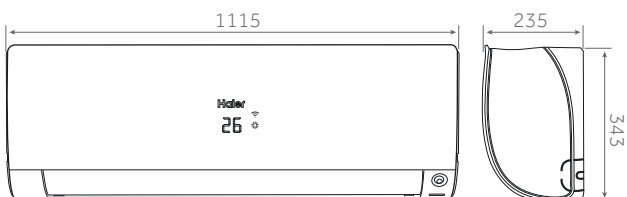

 Pearl

AS25PBAHRA/AS35PBAHRA

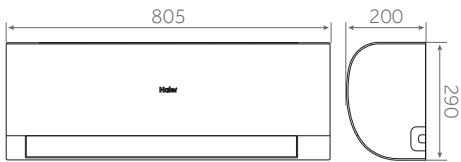

AS50PDAHRA/AS68PDAHRA

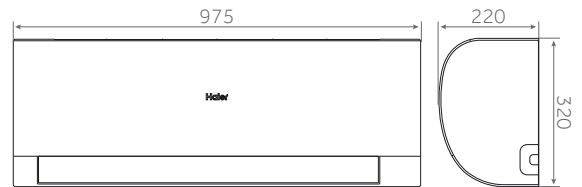

 Tundra Plus

AS25TAEHRA-THC/AS35TADHRA-THC

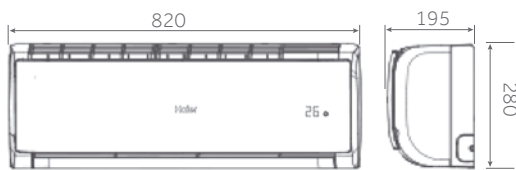

AS50TDDHRA-THC/AS68TDRHRA-THC



 Tide Plus

AS25THMHRA-C/AS35TAMHRA-C

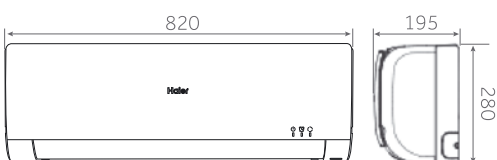

AS50TDMHRA-C /AS68TDRHRA-C

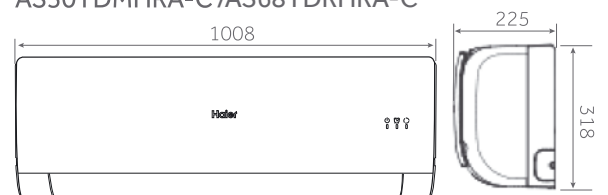

Dimenzije vanjskih jedinica



Jade Super Match

1U25MECFRA-3/1U35MECFRA-3

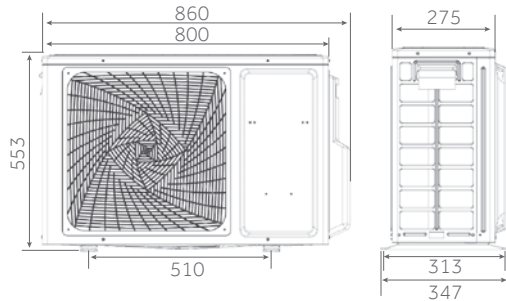

1U50JECFRA-3

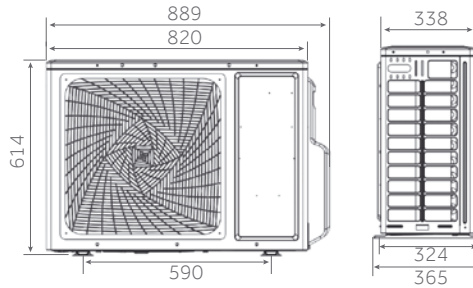

Expert/Flexis Plus

1U25S2SM1FA-2 / 1U35S2SM1FA-2

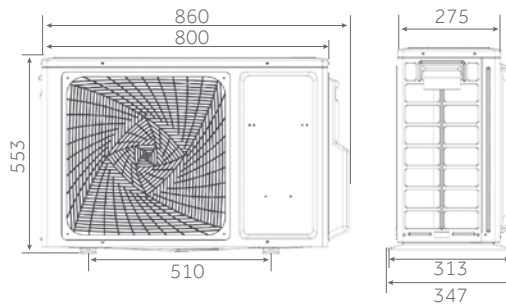

Expert-Nordic

1U25KEHFRA-NR/1U35KEHFRA-NR

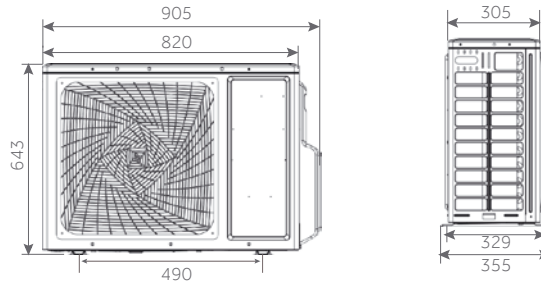

1U71S2SR2FA

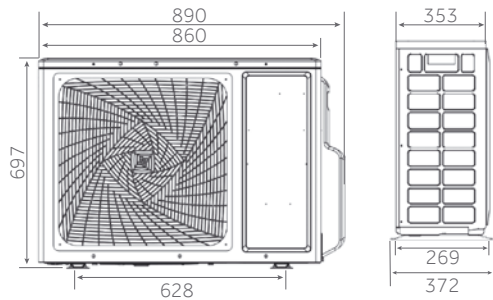

Pearl

1U68WEGFRA

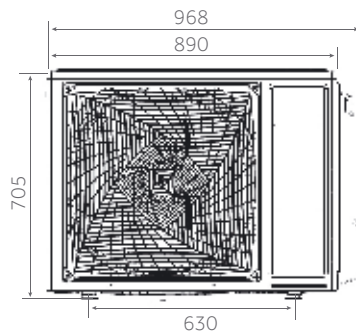

1U25YEGFRA-H1/1U35YEGFRA-H1

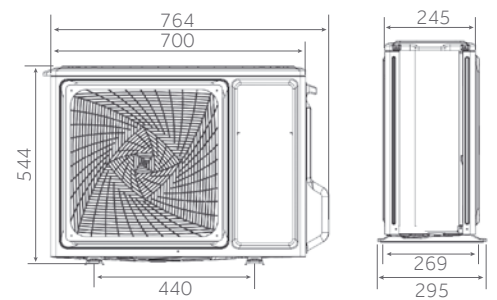

1U50S2SJ2FA-2

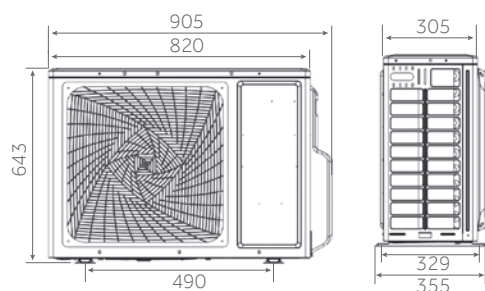

1U50MEGFRA-H

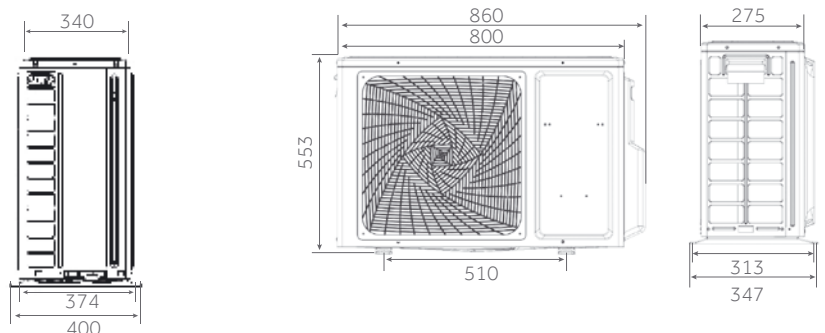



Tundra Plus

1U25YEFFRA-1

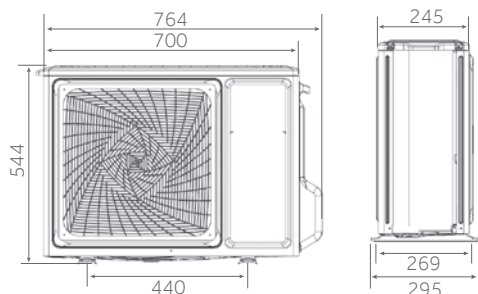

1U35MEEFRA-1/ 1U50MEMFRA-C

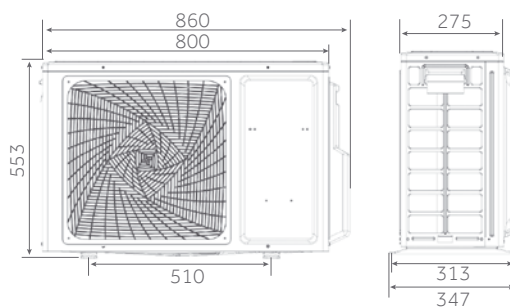

1U68WEGFRA-C

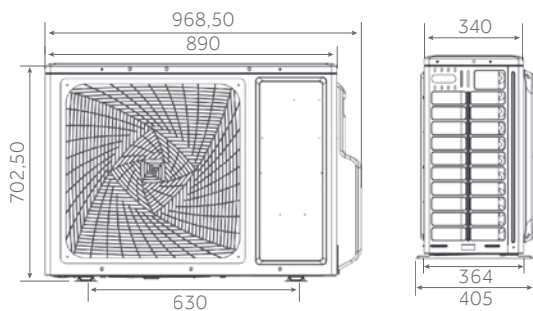

Tide Plus

1U25YEFFRA-C/1U35YEFFRA-C

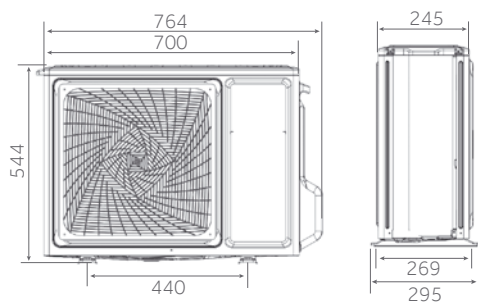

1U50MEMFRA-C

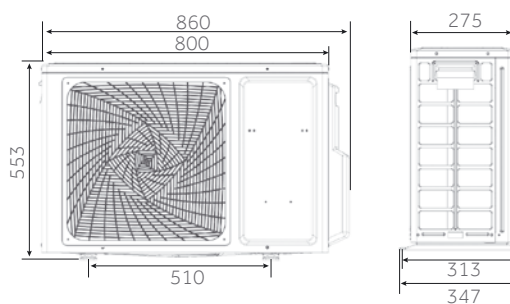

1U68WEGFRA-C

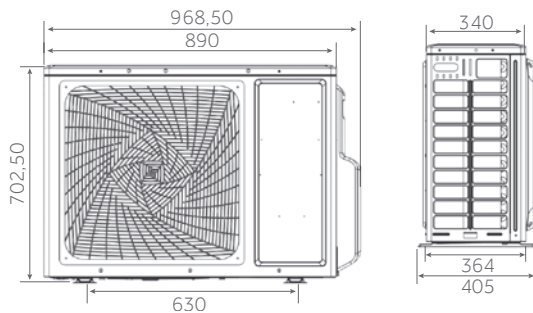

Haier

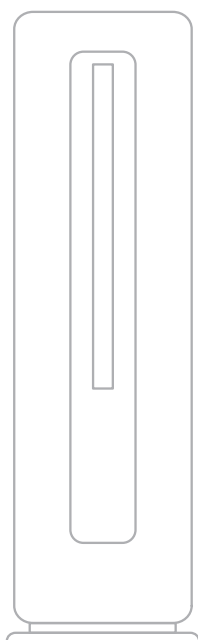
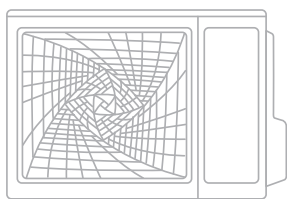

Zagreb

T: +385 (0) 1 66 08 002
trgovina-zg@mbfrigo.hr
Bani 81
10010 Zagreb
Hrvatska

Rijeka

T: +385 (0) 51 683 280
trgovina-ri@mbfrigo.hr
Stupari 28C
51216 Rijeka-Viškovo
Hrvatska

Zadar

T: +385 (0) 23 325 100
trgovina-zd@mbfrigo.hr
Murvica jug 34
23000 Zadar
Hrvatska

Split

T: +385 (0) 21 383 333
trgovina-st@mbfrigo.hr
Put kave 4b
21212 Kaštel Sućurac
Hrvatska

Ne odgovaramo za tiskarske pogreške. Verzija: 06/2023.